

25.
02



euresys
a **TKH Vision** brand

USB3 Windows *macOS*
Linux **DVI OCR GENICAM**
QRCode .NET Fiber Optics
Recorder Gauge MATCH C++

ARM Python *sub-pixel*
PAL/NTSC CoaXPRESS
FPGA Deep Learning **GigE**
CameraLink **3D...**



euresys
a TKH Vision brand

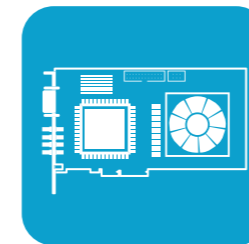

Who are we?

Euresys is a leading and innovative high-tech company, designer and provider of image and video acquisition components, frame grabbers, image analysis software and FPGA IP Cores. Euresys is active in computer vision, machine vision, factory automation and medical imaging.



The company's image acquisition expertise covers analog and digital video acquisition, FPGA programming, high-frequency electronics, video compression and camera control.



Our software image analysis expertise includes 3D inspection, defect detection using deep learning, sub-pixel measurement, pattern matching, color analysis, optical character recognition, barcode reading and verification.

Sensor to Image, a subsidiary of Euresys, is a machine vision specialist developing and providing FPGA based imaging and video IP Core and products. Its expertise encompasses the GigE Vision, CoaXPRESS, USB3 Vision, MIPI and GenICam standards, as well as the AMD and Intel platforms combined with hardware engineering and production know-how.

Euresys is a TKH Technology company.

THE FUTURE OF COAXPRESS

CoaXPress over-Fiber

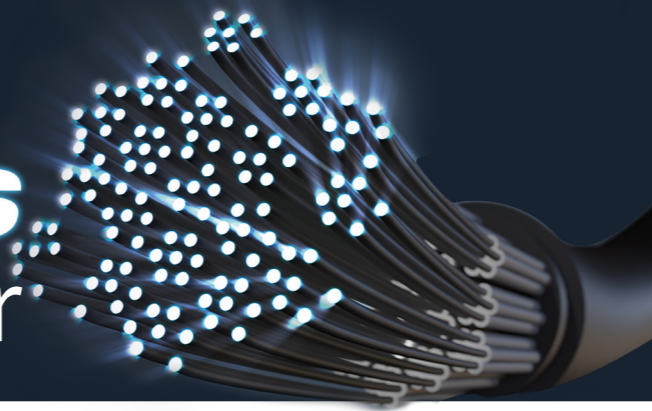

What is CoaXPress-over-Fiber ?

CoaXPress-over-Fiber is a light but significant extension of the existing CoaXPress specification to support transport over fiber optics.

CoaXPress (CXP) is the de-facto standard for high-bandwidth computer vision applications. CoaXPress 2.0, the latest version of the specification, specifies the CXP-12 speed, a 12.5 Gbps (Gigabit per second) link over a coaxial copper cable. As link aggregation is common with CoaXPress, bandwidths of 50 Gbps (12.5 x 4) are easily achievable with four CXP-12 links. The CoaXPress specification is hosted by the JIIA (Japan Industrial Imaging Association).

CoaXPress-over-Fiber has been designed as an add-on to the CoaXPress 2.0 specification. It provides a way to run the CoaXPress protocol, as it is, unmodified, over a standard Ethernet connection, including fiber optics. As such, CoaXPress-over-Fiber uses standard electronics, connectors and cables designed for Ethernet, but the protocol is CoaXPress, not Ethernet, not GigE Vision.



Coaxlink QSFP+

Four-connection CoaXPress-over-Fiber frame grabber

- One QSFP+ port compliant with 40 Gbps optical modules
- 5,000 MB/s camera bandwidth
- PCIe 3.0 (Gen 3) x8 bus: 6,700 MB/s bus bandwidth
- Feature-rich set of 20 digital I/O lines
- Extensive camera control functions
- Memento Event Logging Tool
- Compatible with CustomLogic: Your own FPGA logic



CoaXPress-over-Fiber Bridge IP Core

CoaXPress-over-Fiber Bridge IP Core for FPGA

- Available as CXP to nGMII (device) or nGMII to CXP (host) Bridge IP Cores
- Compatible with AMD 7 Series (and newer), AlteraCyclone/Arria 10/Agilex
- Compatible with S2I and third-party CoaXPress IP Cores
- Delivered with a working reference design (when licensed with the S2I CoaXPress IP Core) and extensive simulation testbench

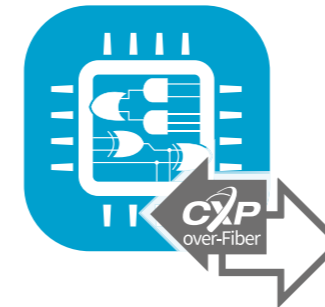

NEW

Coaxlink CXP-12 to QSFP+ Converter

Four-connection CoaXPress CXP-12 to CoaXPress-over-Fiber converter

- Provides easy cable length extension using CoaXPress-over-Fiber
- Allows connecting a CXP-12 camera to a Coaxlink QSFP+ frame grabber
- Four CoaXPress CXP-12 connections on the camera side
- One QSFP+ port compliant with 40 Gbps optical modules on the frame grabber side
- 5,000 MB/s camera bandwidth
- PoCXP camera power supply



LONG CABLE SUPPORT



150 meters on mutlimode fibers at CXP-12 speed

40 kilometers on single mode fibers at CXP-12 speed

Coaxlink series CoaXPress

Ultimate in performance with superior value CoaXPress frame grabbers

PCIe frame grabbers with up to **8 CoaXPress connections**

Feature-rich set of up to **20 digital I/O lines**  **Memento Event Logging Tool**

Extensive camera control functions

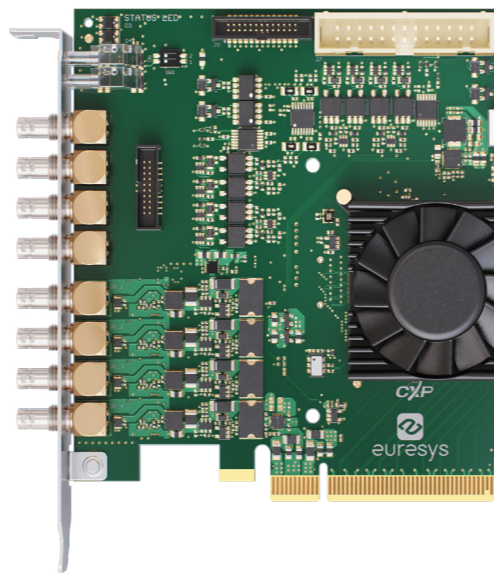

Coaxlink Quad CXP-12 JPEG

Four-connection CoaXPress CXP-12 frame grabber with JPEG compression



- Four 250 MPixels/s JPEG encoders
- Compatible with 8-bit/pixel Bayer CFA cameras
- Two streams per camera: JPEG stream and RGB preview stream
- Four CoaXPress CXP-12 connections: 5,000 MB/s camera bandwidth
- PCIe 3.0 (Gen 3) x8 bus: 6,700 MB/s bus bandwidth

NEW

Coaxlink Quad CXP-12 Value

Four-connection CoaXPress CXP-12 frame grabber



- Four CoaXPress CXP-12 connections: 5,000 MB/s camera bandwidth
- PCIe 3.0 (Gen 3) x8 bus: 6,700 MB/s bus bandwidth
- Feature-rich set of 20 digital I/O lines



Coaxlink Duo CXP-12

Two-connection CoaXPress CXP-12 frame grabber



- Two CoaXPress CXP-12 connections: 2,500 MB/s camera bandwidth
- PCIe 3.0 (Gen 3) x4 bus: 3,300 MB/s bus bandwidth
- Low-profile card. Delivered with standard and low-profile brackets
- Fan-cooled heatsink
- Feature-rich set of 10 digital I/O lines



Coaxlink Quad CXP-12

Four-connection CoaXPress CXP-12 frame grabber



- Four CoaXPress CXP-12 connections: 5,000 MB/s camera bandwidth
- PCIe 3.0 (Gen 3) x8 bus: 6,700 MB/s bus bandwidth
- Feature-rich set of 20 digital I/O lines
- Compatible with CustomLogic: Your own FPGA logic



Coaxlink Mono CXP-12 LH

One-connection CoaXPress CXP-12 frame grabber



- One CoaXPress CXP-12 connection: 1,250 MB/s camera bandwidth
- PCIe 3.0 (Gen 3) x4 bus: 3,300 MB/s bus bandwidth
- Low-profile card. Delivered with standard and low-profile brackets
- Passive (fanless) heatsink
- Feature-rich set of 10 digital I/O lines

Long Cable support



40 METERS at CXP-12 Speed (12.5 Gbps)

72 METERS at CXP-6 Speed (6.25 Gbps)

100 METERS at CXP-3 Speed (3.125 Gbps)



Coaxlink Quad G3

PCIe 3.0 four-connection CoaXPress frame grabber



- Four CoaXPress CXP-6 connections: 2,500 MB/s camera bandwidth
- PCIe 3.0 (Gen 3) x4 bus: 3,300 MB/s bus bandwidth
- Feature-rich set of 20 digital I/O lines
- Fan-cooled or passive heatsink

On-board laser line extraction for 3D profiling



NEW

Coaxlink Quad CXP-12 3D-LLE

Four-connection CoaXPRESS CXP-12 frame grabber with on-board laser line extraction for 3D profiling

- Laser line extraction with zero host CPU usage
- Single and Dual Laser Line Extraction into a depth map
- Real-time generation of 16-bit 3D height maps
- Choice of algorithms: Maximum, Peak, Center of Gravity (COG)
- Precision: up to 1/256 pixel (with Peak and COG algorithms)
- Performance: 76,000 profiles/s from 1024 x 128 images. 152,000 profiles/s from 1024 x 64 images
- Four CoaXPRESS CXP-12 connections: 5,000 MB/s camera bandwidth



Coaxlink Quad 3D-LLE

Quad CXP-6 frame grabber with on-board laser line extraction for 3D profiling

- Laser line extraction with zero host CPU usage
- Single and Dual Laser Line Extraction into a depth map
- Real-time generation of 16-bit 3D height maps
- Choice of algorithms: Maximum, Peak, Center of Gravity (COG)
- Precision: up to 1/256 pixel (with Peak and COG algorithms)
- Performance: 38,000 profiles/s from 1024 x 128 images. 76,000 profiles/s from 1024 x 64 images

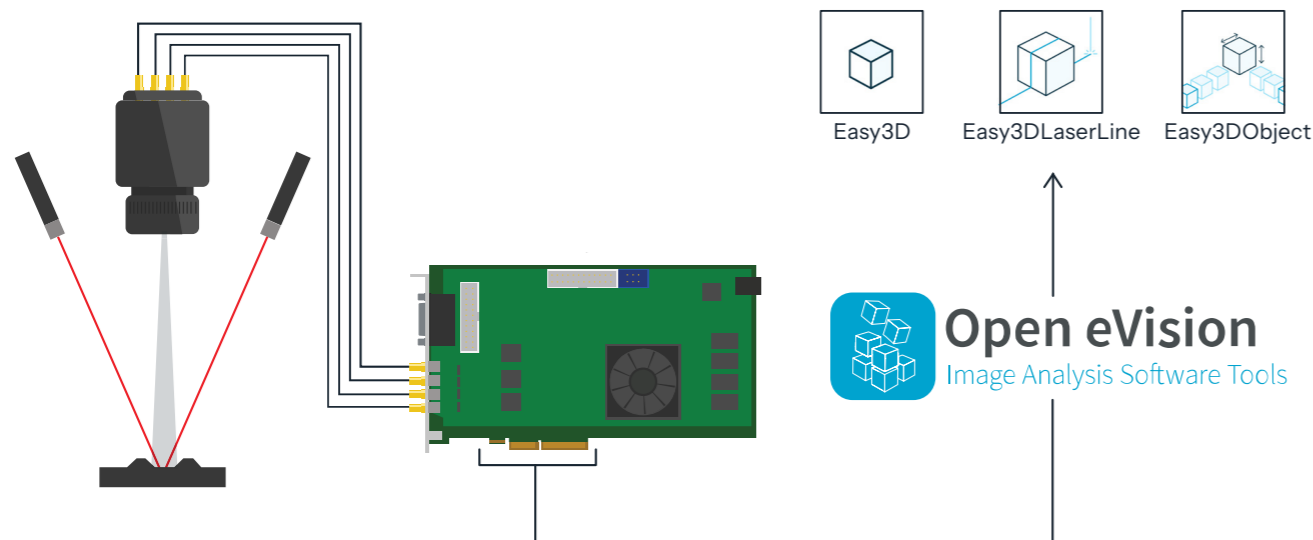

CoaXPRESS Data Forwarding



NEW

Coaxlink Quad CXP-12 DF

Four-connection CoaXPRESS CXP-12 frame grabber with Data Forwarding

- Four CoaXPRESS CXP-12 connections and four Data Forwarding outputs: 5,000 MB/s camera bandwidth
- PCIe 3.0 (Gen 3) x8 bus: 6,700 MB/s bus bandwidth
- Feature-rich set of 10 digital I/O lines



Coaxlink Quad G3 DF

PCIe 3.0 four-connection CoaXPRESS frame grabber with data forwarding

- Four CoaXPRESS CXP-6 connections and four Data Forwarding outputs: 2,500 MB/s camera bandwidth
- PCIe 3.0 (Gen 3) x4 bus: 3,300 MB/s bus bandwidth
- Feature-rich set of 10 digital I/O lines



COAXPRESS DATA FORWARDING

Allows to distribute the image processing workload among several host PCs

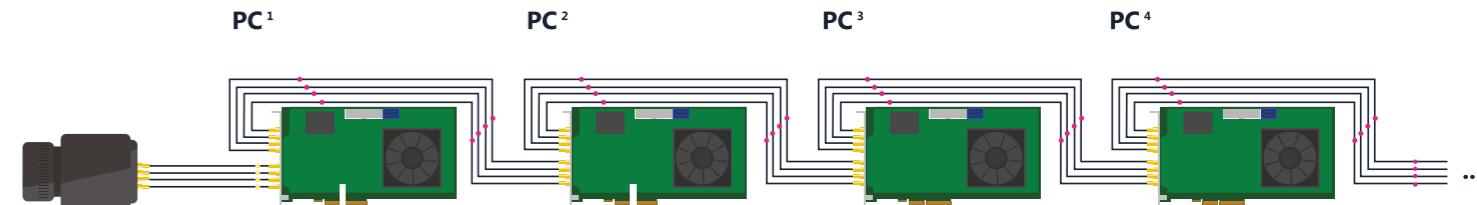

The data forwarding capability allows image data from one camera to be transferred to multiple frame grabbers on different Host PCs to distribute the image processing load. Data can be distributed between up to 10 synchronized daisy chained PCs. PCs can be close to each other or up to 40 meters away.

Multi-camera applications for Coaxlink Octo



Coaxlink Quad Octo

PCIe 3.0 eight-connection CoaXPress frame grabber

- Eight CoaXPress CXP-6 connections: 5,000 MB/s camera bandwidth
- Connect up to eight CoaXPress cameras to one card
- PCIe 3.0 (Gen 3) x8 bus: 6,700 MB/s bus bandwidth
- Feature-rich set of 10 digital I/O lines
- Compatible with CustomLogic: Your own FPGA logic

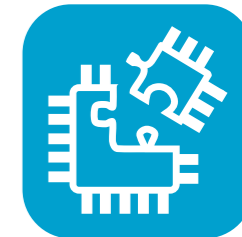

Features

CustomLogic

Your own FPGA logic

FPGA design kit enabling the design and upload of FPGA code to a Coaxlink board

Supported by Xilinx Vivado development tool Memento Event Logging messaging

Compatible with Coaxlink Octo, Coaxlink Quad CXP-12 and Coaxlink QSFP+: 70% of Xilinx Kintex Ultrascale XCKU035 FPGA resources available

Access to CoaXPress camera pixel stream, on-board DDR4 memory and PCIe Gen3 connectivity

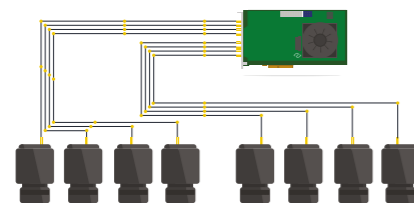

Eight 1-connection cameras

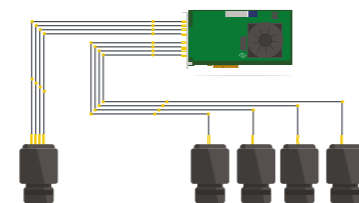

One 4-connection plus four 1-connection cameras

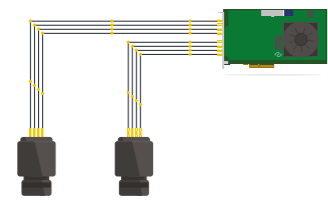

Two 4-connection cameras

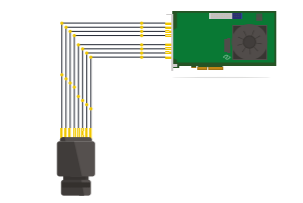

One 8-connection camera

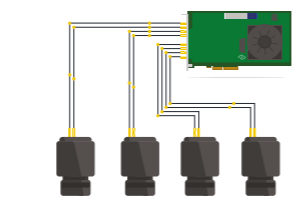

Four 2-connection cameras

What is Custom Logic ?

CustomLogic is an FPGA design kit enabling the design and upload of FPGA code to a Coaxlink board. It is compatible with the Coaxlink Octo, Coaxlink Quad CXP-12 and Coaxlink QSFP+. Typ. up to 70% of their Xilinx Kintex Ultrascale XCKU035 FPGA Logic is available. The design phase uses the Xilinx Vivado development tools (Available free of charge from AMD-Xilinx).

Data pixel Stream Interface

The Data Stream interface is based on the AMBA AXI4-Stream protocol. On the source side, this interface provides the user logic with images acquired from a CoaXPress Device (for example a CoaXPress camera). On the destination side, the Data Stream interface transfers the resulting images/data generated by the user logic to the PCI Express DMA Back-End channel.

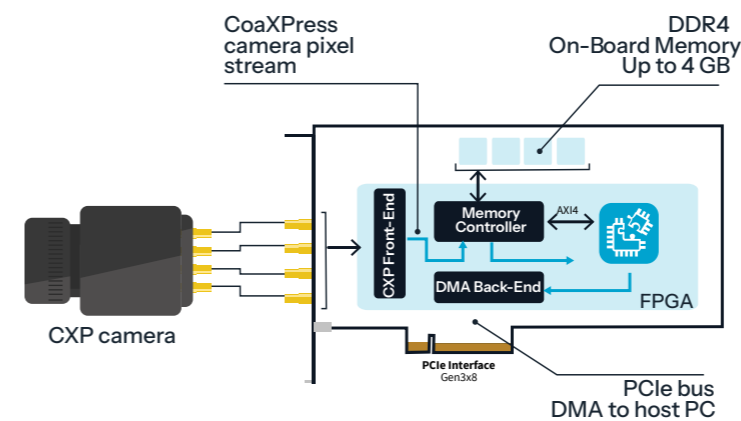

DDR4 Memory interface

The DDR4 Memory interface is based on the AMBA AXI4 protocol.

Resource	Total	Available to the user (%)
LUT	203,128	76
FF	406,256	84
BRAM (36KB)	540	65
DSP	1,700	96

e.g. Resources available to the user of a Coaxlink Quad CXP-12 (1-camera, custom logic) firmware variant. Figures may vary for different firmware variants.

Memento Event interface

The Memento Event interface allows the User Logic to send timestamped events to the Memento Logging tool with a precision of 1 μs. Along with the timestamped event, two 32-bit arguments are reported in Memento.

Control/Status interface

The Control/Status interface allows the user to read and write registers inside the user logic via the Coaxlink Driver API.

Reference design

The Coaxlink CustomLogic SDK is delivered with a reference design intended to be used as a template. The reference design exposes all interfaces available to the user. It is a AMD Vivado project with the following functional block diagram:

Debugging

Using CustomLogic does not require any additional hardware. The 3613 JTAG Adapter AMD for Coaxlink (available free of charge from AMD) allows connecting the AMD programmer to the Coaxlink FPGA for debugging purposes.

Features

eGrabber

Image acquisition software



Set of tools for image acquisition and recording

Compatible with CoaXPress cameras (with the Coaxlink cards)

Compatible with Camera Link cameras (with Grablink Duo)

Compatible with GigE Vision cameras (with the optional Gigelink library)

Recording to hard drives (with the optional Recorder library)

GEN*i*CAM

Set of software drivers, tools and applications that enable and simplify the development and debugging of computer vision applications using CoaXPress, Camera Link and GigE Vision cameras.

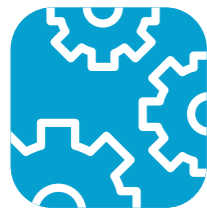

eGrabber Driver

Coaxlink and Grablink Duo driver

- C++, C# and Python APIs
- Support for single-thread and multi-thread callbacks for real-time event handling
- Support for script files to configure the frame grabber and camera
- Compatible with GenICam, GenApi and GenTL
- Compatible with Windows, Linux and macOS



eGrabber Studio

Powerful image acquisition

- eGrabber's evaluation and demonstration application
- Compatible with GigE Vision cameras (with the optional Gigelink library), CoaXPress cameras (with the Coaxlink cards) and Camera Link cameras (with Grablink Duo)
- Recorder pane giving access to image recording with the optional eGrabber Recorder library
- Compatible with Windows, Linux, and macOS

eGrabber add-ons



eGrabber Gigelink

GigE Vision image acquisition library

- Image acquisition from GigE Vision cameras within eGrabber
- Universal, compatible with any GigE Vision camera
- Hardware independent
- Compatible with Windows and Linux platforms

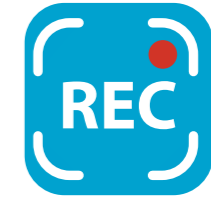

eGrabber Recorder

High-performance video recording library

- Highly optimized video recording to disk
- Recording at bandwidth compatible with fast cameras
- Long term recording, limited only by the disk size
- Includes UTC timestamping
- Export to standard TIFF and MKV files
- Compatible with Windows and Linux platforms

NEW

eGrabber Playlink

Virtual frame grabber and camera for Machine Vision

- Standard GenTL producer
- Acquire images recorded in eGrabber Recorder containers
- Accelerate application development
- Compatible with Windows and Linux platforms
- Memento Event Logging Tool

eGrabber Playlink description

eGrabber Playlink is a game-changing feature that allows software developers to test and validate their code without the need for physical acquisition cards and cameras. This virtual frame grabber simulates the image acquisition process, enabling developers to work independently of the machine's physical environment.

Playlink is a standard GenTL (Generic Transport Layer) producer capable of acquiring images recorded by eGrabber Recorder from a real-world acquisition system.

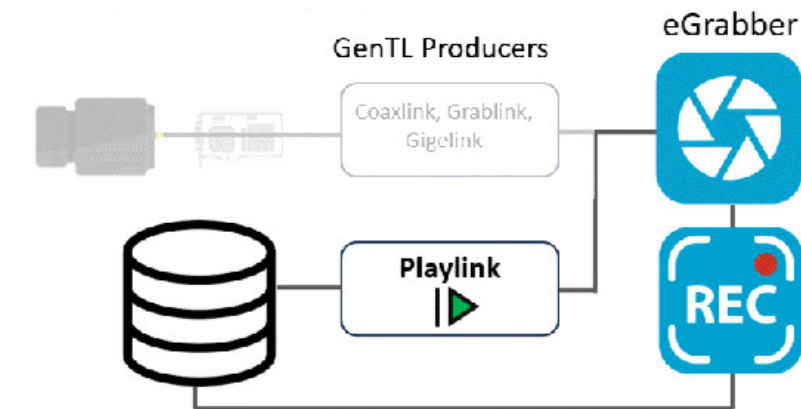

It allows developers to focus on the machine vision software application and its validation without worrying about the complexities of image acquisition.

eGrabber Playlink can be used free of charge within eGrabber Studio, which is a great way to learn and evaluate Playlink.

Image Acquisition Software

eGrabber Memento

Event logging tool



Accurate logging of events related to the camera, the frame grabber and its driver as well as the host application

Graphical representation of time-stamped events on a precise timeline with context information

Logic analyzer feature to help users analyze selected system events Non-intrusive tool requiring low CPU usage

Support for setting up, debugging and profiling the system Availability with all Coaxlink and Grablink cards in the PC

Compatible with Windows, Linux, and macOS

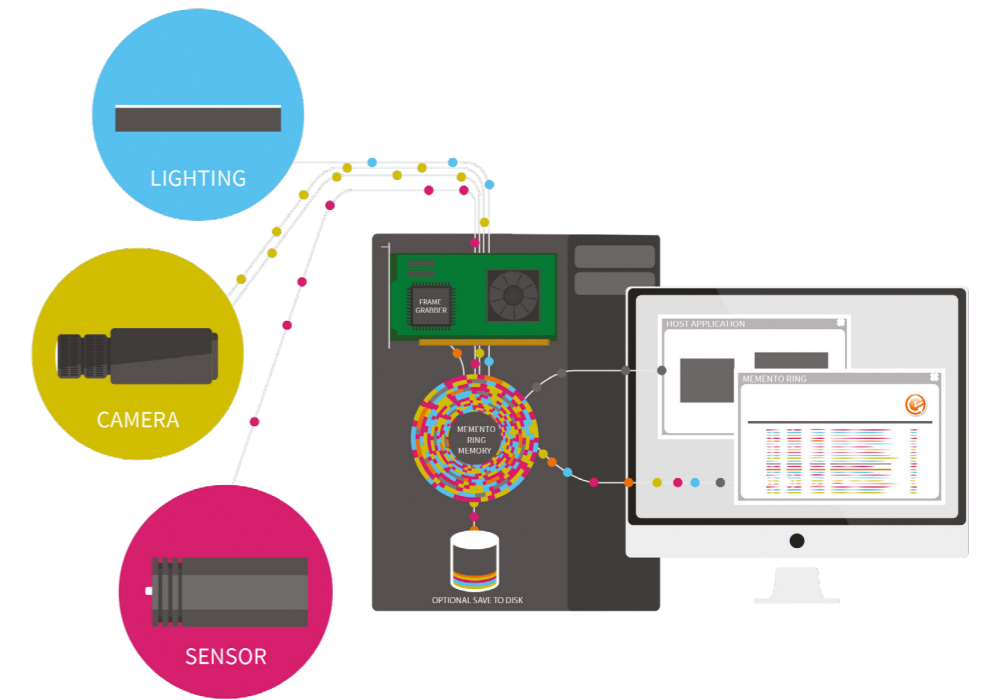

What is Memento?

In high-end inspection machines using vision, the frame grabber is responsible for acquiring images in synchronization with numerous external devices such as motion or lighting controllers, not to mention the camera itself. Debugging these systems often requires complex equipment, for example, oscilloscopes and logic analyzer, which are used along with software profilers

The problem is even more acute with the latest cameras available, which allow for very fast frame rates exceeding several hundred, even thousand frames per second. Memento has been designed to simplify that process. During the operation, Memento records a very detailed log of events related to the camera, the frame grabber and its driver, as well as the host application.

How does Memento work? Non-intrusive and powerful tool

The Memento driver records events such as driver function calls, callbacks, triggers received by the frame grabber, strobe signals sent to the light controller or camera control signals, along with precise time stamps and detailed context information.

In the Memento application, you can display a list of these events with their associated time stamp and useful context information. The events listed are also displayed in a timeline.

Different levels of verbosity are used to filter and display only the most crucial messages or to provide much more detailed log information. Additional display and highlighting options are available based, among others, on the origin or nature of the messages. Search features also allow you to find back messages based on their content.

Memento assists developers during application development and debugging, as well as system operation. It helps them understand the behavior of the machine and pin down the cause of issues such as missed triggers or lost images.

Memento runs in the background and builds logs that can be saved and sent back to the support team in case of machine failure. Memento relies on software resources implemented inside the driver of the cards as well as hardware resources on the cards themselves. Memento has been designed to be extremely efficient. It is non-intrusive as the required CPU load is extremely low.

Memento is very powerful as it can collect extremely diverse logging information and provide extensive filtering capabilities, at several levels, based on the nature of logging information or on the requested verbosity level.

Memento analyzer

Memento provides a logic analyzer tool, called Memento Analyzer, that receives detailed, sequenced and timing information to help measure latencies and detect defects during acquisition.

The Memento Analyzer displays system events (trigger, strobe, DMA, ...) on a timeline. It analyzes how buffer queues are used and how acquired images are delivered to the application. It also displays detailed information about incoming protocol data (CoaXPress, ...).

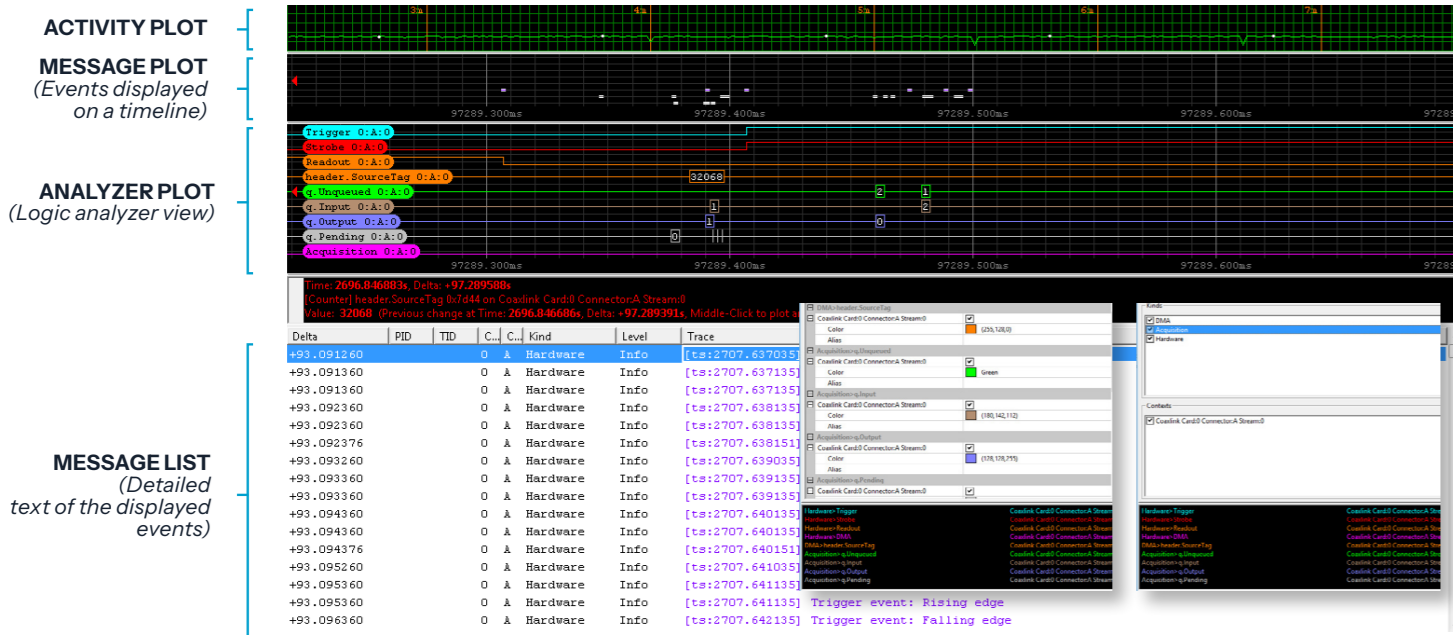

Grablink series Camera Link

Ultimate in performance with superior value Camera Link frame grabbers

PCIe frame grabbers for Camera Link 80-bit, Full, Medium, Base and Lite configuration cameras

Directly compatible with hundreds of Camera Link cameras available on the market

  ECCO+ / ECCO: Extended Camera Link Cable Operation

Feature-rich set of digital IO lines  Memento Event Logging Tool

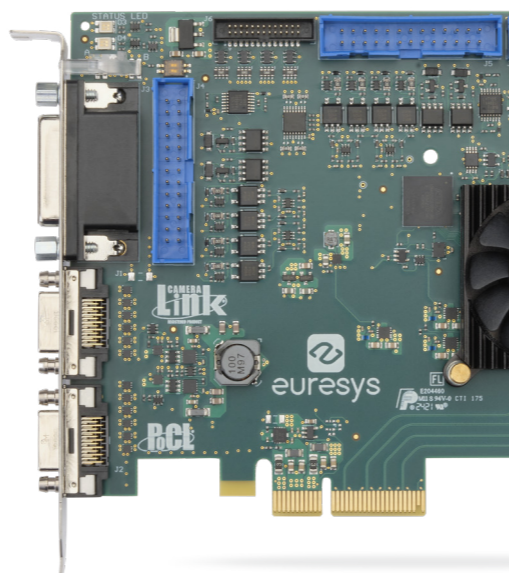

Grablink Full

Frame grabber for one full-configuration Camera Link camera

- For one Camera Link 80-bit, 72-bit, Full, Medium or Base configuration camera
- Directly compatible with hundreds of Camera Link cameras available on the market
- ECCO: Extended Camera Link cable length
ECCO+: Double Camera Link maximum cable length
- PCIe x4 bus: 850 MB/s sustained delivery bandwidth
- Feature-rich set of 10 digital IO lines

Grablink DualBase

Frame grabber for two base-configuration Camera Link cameras

- For two Camera Link Base or Lite configuration cameras
- Directly compatible with hundreds of Camera Link cameras available on the market
- ECCO: Extended Camera Link cable length
- PCIe x4 bus: 850 MB/s sustained delivery bandwidth
- Feature-rich set of 20 digital IO lines

Grablink Base

Frame grabber for one base-configuration Camera Link camera

- For one Camera Link Base or Lite configuration camera
- Directly compatible with hundreds of Camera Link cameras available on the market
- Supports PoCL, Power over Camera Link
- ECCO: Extended Camera Link cable length
- PCIe x1 bus: 200 MB/s sustained delivery bandwidth
- Feature-rich set of 10 digital IO lines

Picolo HD 3G DVI

3G 60FPS DVI high-definition 1080p video capture card

- Video and audio capture from DVI, Y/Pr/Pb, S-Video or CVBS video sources
- HD 1920x1080p50/60
- SD 525i60 and 625i50
- 16 general purpose IO lines
- PCIe (2.0) Gen2 x1 bus

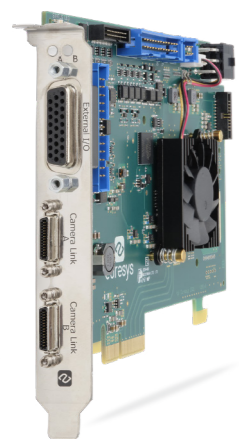

NEW

Grablink Duo

Frame grabber for one full- or two base-configuration Camera Link cameras

- For two independent Camera Link Base configuration cameras
- For one Camera Link Base, Medium, Full, 72-bit or 80-bit camera
- Directly compatible with hundreds of Camera Link cameras available on the market
- PoCL, Power over Camera Link
- ECCO: Extended Camera Link cable length
- PCIe Gen 2 x4 bus
- Feature-rich set of 20 digital IO lines
- Compatible with eGrabber Driver & Memento Event Logging Tool

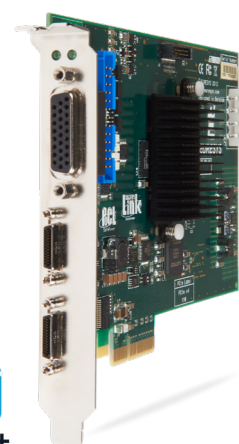

Grablink Full XR

Frame grabber for one full-configuration Camera Link camera with support for extra long cables

- For one Camera Link 80-bit, 72-bit, Full, Medium or Base configuration camera
- Directly compatible with hundreds of Camera Link cameras available on the market
- Supports PoCL, Power over Camera Link
- ECCO+: Double Camera Link maximum cable length
- PoCL SafePower compliant
- PCIe x4 bus: 850 MB/s sustained delivery bandwidth
- Feature-rich set of 10 digital IO lines

Machine Vision Software

Open eVision

Image analysis libraries and software tools

Hardware-independent image processing and analysis libraries for machine vision inspection applications

Compatible with any image source, including frame grabbers, GigE Vision and USB3 Vision cameras

Support for the latest technologies such as Deep Learning and 3D

Accurate sub-pixel measurement and calibration

64-bit libraries for Windows (x86-64) and Linux (x86-64 and ARMv8-A)

Supporting C++, Python and .NET framework (C#, VB.NET, C++/CLI)

Easy to learn and use

Robust, flexible and powerful

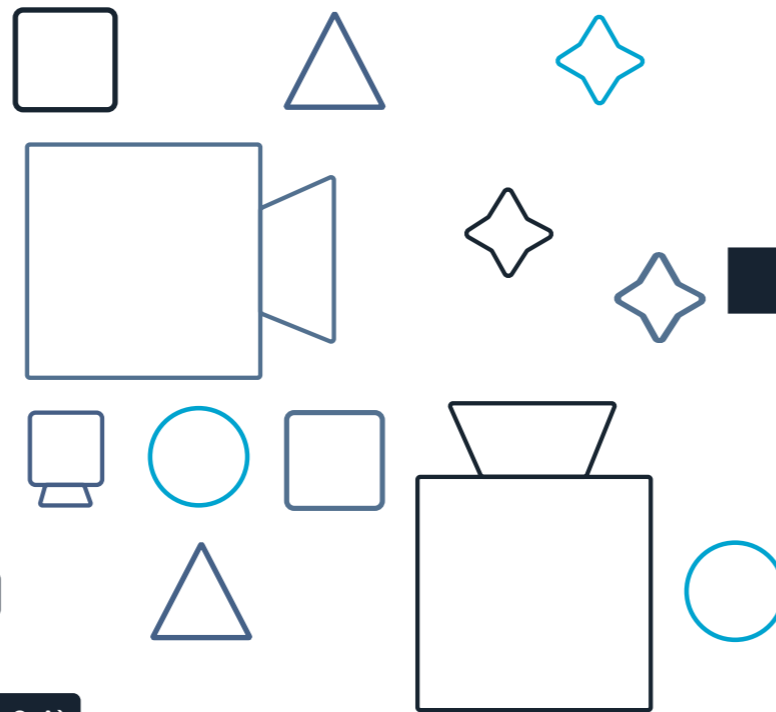

Inspection with Deep Learning

General purpose

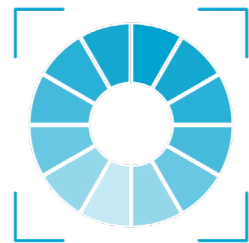

EasyColor

Color image analysis library

- Fast conversion of images between 11 color spaces
- Color segmentation: to identify objects based on their color
- Color verification: to verify the color of objects



EasyImage

Image processing library

- Set of optimized fundamental image processing and analysis functions
- Convolution and morphology
- Geometric transformations
- Histogram computation and analysis
- Noise estimation and reduction
- HDR (High Dynamic Range) image fusion

Applicative processing



EasySpotDetector

Advanced surface inspection for battery, paper, film or glass industries

- Detection of faint defects and contamination, even in noisy images
- Fast processing for in-line inspection
- Compatible with acquisition from line-scan and 2D cameras
- Optional pre-alignment of the region of interest on part's edges
- Optional Deep Learning classification of the defects
- Simple and comprehensive C++, C# and Python API

NEW



Deep Learning Studio

Deep Learning training and evaluation application

- Ease the evaluation of Open eVision's Deep Learning tools
- Dataset creation and image annotation
- Create and configure dataset splits to decide how your images are used
- Manage the data augmentation transformations
- Train your tools in succession thanks to the training queue
- Validation and analysis of the results of the trained tools
- Available on Windows and Linux
- Free of charge

Download Open eVision
Deep Learning Studio
for free evaluation on www.euresys.com

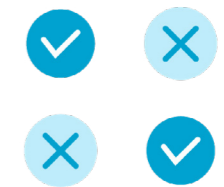

EasyClassify

Deep Learning classification library

- Includes functions for classifier training and image classification
- Detects defective products
- Sorts products into various classes
- Supports data augmentation



EasySegment

Deep Learning segmentation library

- Unsupervised mode: train only with "good" images to detect and segment anomalies and defects in new images
- Supervised mode: learn a model of the defects for better segmentation and detection precision
- Works with any image resolution
- Supports data augmentation and masks



EasyLocate

Deep Learning localization and classification library

- Localization and identification of objects/products/defects
- Counting of objects
- Axis Aligned Bounding Boxes
- Interest Point
- Supports data augmentation and masks

- Compatible with CPU and GPU processing
- Deep Learning Studio for dataset creation, training and evaluation
- Only available as part of the Deep Learning Bundle

3D processing



Easy3D Match

3D alignment and inspection library

- Align a scanned 3D object with another scan or with a reference mesh
- Compute the local distances between 3D scans and a golden sample or reference mesh
- Detect anomalies such as misplaced features, geometric distortions, gaps, bumps,...
- Compatible with all 3D sensors that produce point clouds, depth maps or height maps

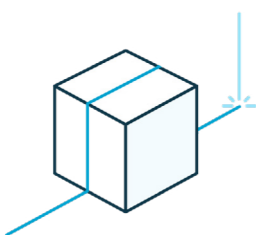

Easy3DLaserLine

3D laser line extraction and calibration library

- Single and Dual Laser Line Extraction into a depth map
- Convenient and powerful 3D calibration for laser triangulation setups
- Compatible with the Coaxlink Quad 3D-LLE frame grabber



Easy3D

3D image processing library

- Point cloud processing and management
- Flexible ZMap generation
- 3D processing functions for cropping, decimating, fitting and aligning point clouds
- Compatible with many 3D sensors
- Interactive 3D display with the 3D Viewer

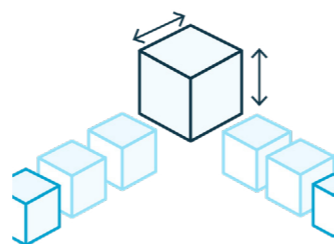

Easy3DObject

3D object extraction and measurement library

- Detection of 3D objects in point clouds or ZMaps
- Metric detection criteria
- Compatible with arbitrary regions
- Computation of precise 3D measurements, like size, orientation, area, volume...
- Automatic extraction of object local support plane
- 2D and 3D graphical display of the results
- Full-featured interactive demo application

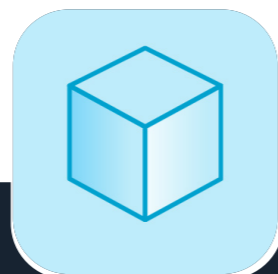

3D Studio

3D evaluation and prototyping application

- Ease the configuration and the setup of a laser triangulation scanner using the Coaxlink Quad 3D-LLE
- Simplify the calibration procedure
- Display interactive Depth Maps, 3D Point Clouds and Zmaps
- Free of charge

Download Open eVision 3D Studio for free evaluation on www.euresys.com

COMPATIBILY WITH 3D SENSOR



Text and code reading



EasyMatrixCode

2D Data Matrix code reading library

- Automatic detection of the code in the image
- Decodes ECC200, ECC000, ECC050, ECC080, ECC100 and ECC140 codes
- Computes quality indicators as per ANSI/AIM, ISO/IEC 15415, ISO/IEC TR 29158 and SEMI T10-0701 standards
- Very fast operation
- Impressive robustness to noise, blur and distortion
- Support of GS1 Data Matrix codes
- Efficient reading of codes in grid layout
- Multiple codes reading



EasyBarCode

Bar code reading library

- Automatic detection of the barcode in the image
- Automatic detection of the symbology
- Very fast and robust
- Full support of numerous symbologies
- Mail Barcode Reader
- Multiple codes reading
- Grading according to ISO/IEC 15416



EasyQRCode

QR code reading library

- Automatic detection of the code in the image
- Decodes model 1 and model 2 QR codes, all versions, all levels
- Decodes Micro QR codes
- Very fast operation
- Impressive robustness to noise, blur and distortion
- Error detection and correction
- Rotation and flipping invariant
- Print quality verification with grading standards
- Multiple codes reading

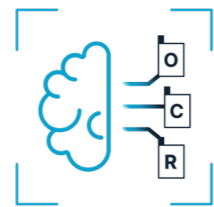

EasyDeepOCR

NEW

Deep learning based Optical Character Recognition library

- Tool designed for industrial markings, like serial numbers, expiry dates, part numbers...
- Very easy to use, simple API and no training required
- Optional topology definition to filter out non-relevant texts
- Focus on text reading capability without compromising speed
- Optional optimization of the processing pipeline with a few examples
- Run on CPU and GPU, Intel and ARM platforms



EasyOCR

Optical character recognition library

- Teachable character recognition for the most reliable and fastest recognition
- Invariant to character size
- Tolerant to poorly printed, broken characters
- "Connected" characters separation
- Pre-defined fonts included



EasyOCR2

Industrial optical character recognition library

- Optimized for reading short texts such as part numbers, serial numbers, expiry dates, manufacturing dates, lot codes, ...
- Innovative segmentation algorithm to automatically locate texts in the image based on expected character size and text topology
- Full support for text rotation (360 degrees)
- Able to read severely degraded characters: support for character fragmentation and uneven lighting
- Learning of character database from one or multiple TrueType Font or by your own sample images
- Assisted learning of character database from sample images
- Character database management: adding characters; saving, loading database
- Pre-trained classifier powered by deep learning technologies suitable for industrial text marking fonts

Matching and measurement

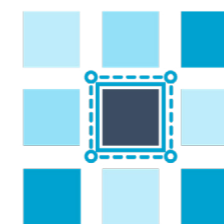

EasyObject

Blob analysis library

- Image segmentation based on the gray scale of connected objects
- Object labeling
- Geometric feature extraction
- Flexible Masks
- High performance, especially for large images and images with numerous objects

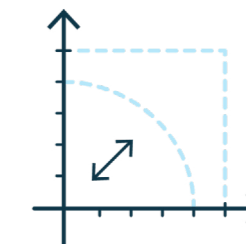

EasyGauge

Sub-pixel measurement & dimension control library

- Sub-pixel point location and edge fitting
- Highly accurate and robust
- Advanced and automatic calibration
- Multiple gauge models
- Measurement of position, orientation, size, curvature, distance
- Interaction through graphical interface



EasyFind

Geometric pattern matching library

- Pattern matching using a feature point technology
- Learn from image or DXF vector model
- Fully automatic, fast and robust
- Invariant to rotation and scaling
- High tolerance to pattern degradation
- Support of "don't care" areas



EasyMatch

Pattern matching library

- Pattern matching using normalized correlation
- Sub-pixel accuracy
- Rotation and scaling support
- Detection of multiple pattern occurrences
- Support of gray scale and color images
- Support of "don't care" areas



New Open eVision Studio

Evaluation and prototyping application

- Create complex processing sequences
- Full support of regions of interest and flexible regions
- Comprehensive configuration panels for Open eVision tools
- C++, C# and Python code generation
- Tool and sample catalog
- Connection to live image sources using eGrabber Studio
- Compatible with Windows (10 min), Linux, Intel and ARM architectures
- Free of charge



Open eVision Studio

Evaluation and prototyping application

- Intuitive graphical user interface
- Live display of any Open eVision function
- Generate C++, C# and Visual Basic code
- Free of charge

Download Open eVision Studio for free evaluation on www.euresys.com



More at www.euresys.com

Europe Euresys S.A. - sales.europe@euresys.com - America Euresys Inc. - sales.americas@euresys.com - Asia Euresys Pte. Ltd. - sales.asia@euresys.com

Japan Euresys Japan K.K. - sales.japan@euresys.com - China Euresys Shanghai & Shenzhen Liaison Offices - sales.china@euresys.com

South Korea Euresys Seoul Liaison Office - sales.korea@euresys.com