

TX Series Backlight

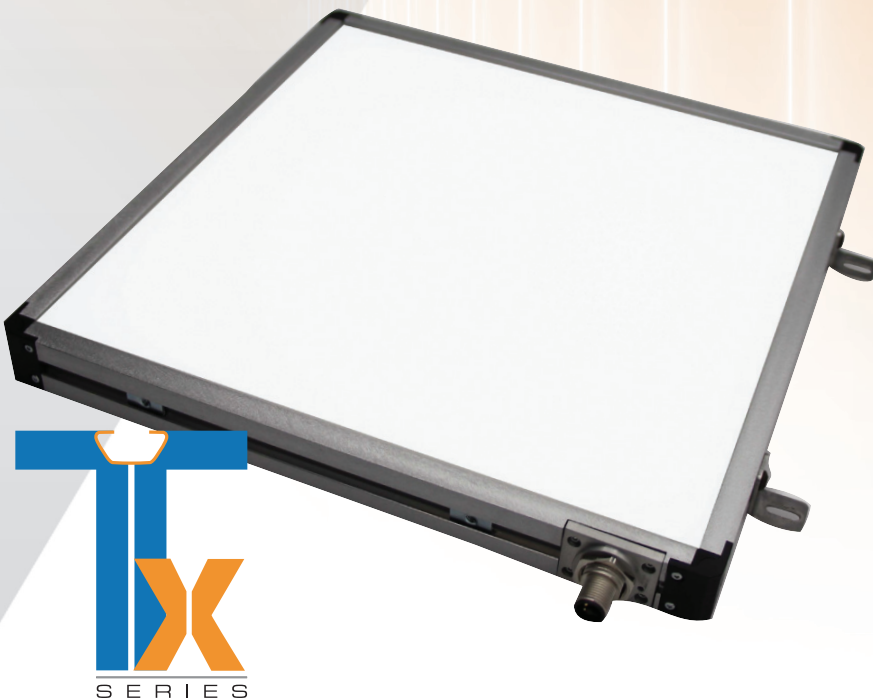

Advanced Performance for Machine Vision
Inspection, Measurement, and Gauging

The TX Backlight Difference

The TX Series of Back Lights provides superior performance for the most demanding machine vision applications. Utilizes a bright and highly uniform array of LEDs. State-of-the-art driver technology delivers instant start-up and flicker-free operation and can be used both in DC continuous operation or with 4x Optical, Pulse-Follow Strobe. Optimize your application, maintain flexibility and minimize technical risk with the exceptional results obtained from the TX Series Back Lights from Metaphase Lighting Technologies.

- ◆ Best for high-contrast, high-accuracy inspection, measurement and gauging applications.
- ◆ New, state-of-the-art driver and microchip - continuous DC with 4x Optical Strobe all-in-one
- ◆ Maximum installation flexibility with 180-degree adjustable T-slot L-brackets (included).
- ◆ High-uniformity and brightness provided by a full array of high-density LEDs.
- ◆ Low-profile housing with 10mm bezel, ideal for space-limited applications.
- ◆ Multispectral: 35 possible combinations by selecting up to four colors.

Features

- 4-sided T-slot based aluminum extrusion. T-nuts supplied. (M4-0.7p x 6mm hex key head).
- Ultra-Slim 10mm housing bezel, maximizes active area relative to footprint.
- Compact 25mm height.
- External Trigger Included.
- Bulkhead 5-pin M12 A-code connector(s) for standard version, 4-pin M12 T-code for external driver version.
- Built-in high-efficiency, dimmable, constant current driver (standard version) with 4x optical strobe standard.
- Optional polarizer filter is a simple field replace/retrofit.

Ordering Info

TXBL / TXCBL Part Numbers and Sizes

TXBL available in 25mm (1 in nominal) increments, up to 1000x1000 units



TX Series
Back Light



TABLE 1: PART NUMBER KEY

Contact your Metaphase Sales representative for custom versions (intensity, uniformity, wavelengths, sizes, etc).

Family	Model	Active Area 1 unit = 25mm	Wavelength	Polarizer
TXBL TXCBL	XX	XXXX <i>small dimension first</i>	XXXXXX	XXXXX
TXBL	1A - ULC/ext. driver	0202-1640	W (White 5700K, Nominal)	Blank if no polarizer
TXCBL (Collimated)	1B- DC internal driver	0202-1616	B (Blue 470nm)	POL0
	1C - continuous with pulse follow 4x strobe		G (Green 530nm)	POL90
			R (Red 630nm)	
			RGB (630nm, 520nm, 470nm)	
			RGBW (630nm, 520nm, 470nm, 5700K)	
			IR850	
			IR940	

Custom M12 connectors are available. Contact your Sales Manager for custom part number.

Example 1: TXBL1C-1010-W

Backlight: Internal driver with 4X strobe | 250mm x 250mm | white | no polarization

Example 2: TXCBL1A-1212-RGBW-POL0

Collimated Backlight: ULC compatible driver | 300mm x 300mm | red, green, blue, white | polarized in long direction

Accessories	Part Number	Description
Standard Version		
DDC Controller	DDC-3	DIGITAL DIMMING CONTROLLER, 3-CHAN 0-10V OUTPUT <i>Note: Requires 24VDC, 1A power supply</i>
3m cable	CAB-FM12FL-3M	3 METER EXTENSION CABLE, FEMALE M-12 A-CODE 5-PIN TO FLYING LEADS
5m cable	CAB-FM12FL-5M	5 METER EXTENSION CABLE, FEMALE M-12 A-CODE 5-PIN TO FLYING LEADS
10m cable	CAB-FM12FL -10M	10 METER EXTENSION CABLE, FEMALE M-12 A-CODE 5-PIN TO FLYING LEADS
U Version		
ULC-2 Controller	ULC-2	UNIVERSAL LED CONTROLLER, TWO-CHANNEL, WITH ULC-2 CONNECTORS <i>Note: Requires 24VDC power supply, 6.7A, to run at full capability</i>
3m cable	CAB-FM12TU-3M - For 1 channel	3 METER EXTENSION CABLE, FEMALE M12 T-CODE 4-PIN TO ONE ULC CONNECTOR, LED POS ON PIN 1&2, LED NEG ON PINS 3&4
3m cable	CAB-FM12T2U-3M - For 2 channels	3 METER EXTENSION CABLE, FEMALE M12 T-CODE 4-PIN TO TWO ULC CONNECTOR, LED POS CHAN A&B ON PINS 1&2, LED NEG CHAN A&B ON PINS 3&4

Available Wavelengths



*Note:
Available in
many more color
combinations*



General	
Operating Temperature	0-40°C, 90% RH, non-condensing*
IP Rating	IP50
Storage Temperature	0-70°C, 90% RH, non-condensing
Compliance	RoHs, CE, IEC 61000-6-2, 61000-6-4, 61010-1
Photobiological Risk Factor**	Exempt
Warranty	2 Years
* Contact your Metaphase sales engineer for higher temperature environments.	
**Full documentation available upon request.	
Electrical	
Supply Voltage	24VDC+/-5%
Standard Version (-DC)	
0-10V Dimming Control (TXBL TXCBL)	Off: 0V Turn-on Threshold: 0.5V
<i>Note: 0-10V Must be connected to turn light on and to trigger.</i>	100% Intensity: 10V Maximum allowance voltage: 10V-24V
Input Impedance	≥180kΩ/1300 cm ² increment, per wavelength
Trigger Input:	
Min Trigger Pulse = 2.5μs	PNP (See Figure 1)
Max trigger rate = 5 kHz	Voltage Enable > 1.39V
Trigger turn-on delay = 51μs	Voltage Disable < .56V
Trigger turn-off delay = 5μs	NPN (See Figure 2)
	Input Impedance = 10kΩ
<i>Note : For continuously ON @ full intensity connect 24VDC power supply to +24V, 0-10VDC and PNP trigger-in inputs</i>	
Optical	
Light Source	LED
LED Array Density	High Density Precision Chip Technology (HDPCT)
Available Wavelengths	470, 530, 630, 850, 940
Intensity	W - 86,000 Lux, R - 79,000 Lux, G - 79,000 Lux, B - 12,000 Lux
Available Color Combinations	W(5700K), RGB, RGBW, WIR850 (5700K/850), WIR940 (5700K/940)
Lifetime	L70 = 75,000 hours
Polarizer	

Mechanical (all units metric)

Housing	25mm profile with 10mm bezel, made of clear anodized aluminum
Mounting	(2) T-nuts minimum per side, pre-installed
Outside Dimensions (OD)	OD = Active Area + 20mm (see Figure 12)
Active Area Designation	Part Number "TXBLXYY" indicates the Active Area is "Ax" by "Ay" See Table 1 "Part Number Key"
L-Bracket Mounting	Center-to-center mounting hole distance = Active Area + 40mm (see Figure 13)
Fasteners	M4-0.7px6mm hex key head
Weight (kg/mm ²)	See Table 6: "Weight (kg) for Active Area Width and Length"
Bulkhead Male M12	See Table 4: "Max Current Draw and Number of Connectors per Size (-DC Version)" Note: "Long Side Right" is default location.

TXBL/TXCBL 1B/1C Versions (M12A Connector)



M12A Bulkhead, 5-pos male TXBL Interface Cable with M12A female connector

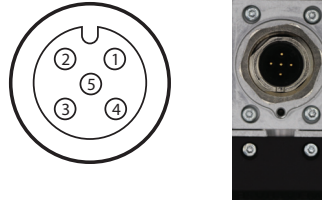
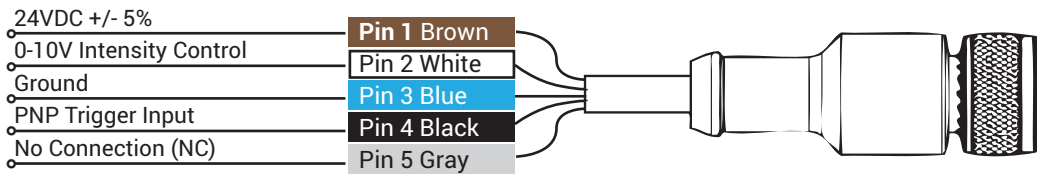

FIGURE 1: TXBL INTERFACE CABLE, M12 5-PIN A-CODE FEMALE CONNECTOR



Note: For continuously ON @ full intensity connect 24VDC power supply to +24V , 0-10VDC and PNP trigger-in inputs.

Note: Common wiring configurations shown. Certain size & # of colors combinations require different wiring. Please refer to documentation supplied with product for exact wiring instructions.

TABLE 2: TXBL/TXCBL INTERFACE CABLE WITH AN M12A FEMALE CONNECTOR

M12A Wiring					
Connector #1	Pin 1	Pin 2	Pin 3	Pin 4	Pin 5
1 Wavelength (Note 1)	24V	Wavelength #1: 0-10V	GND	TRG	NC
2 Wavelengths (Note 1)	24V	Wavelength #1: 0-10V	GND	TRG	Wavelength #2 : 0-10V
3 Wavelengths	24V	Wavelength #1: 0-10V	GND	TRG	Wavelength #2: 0-10V
4 Wavelengths	24V	Wavelength #1: 0-10V	GND	TRG	Wavelength #2: 0-10V
Connector #2					
1 Wavelength (Note 1)	24V	NC	GND	NC	NC
2 Wavelengths (Note 1)	24V	NC	GND	NC	NC
3 Wavelengths	24V	Wavelength #3: 0-10V	GND	NC	NC
4 Wavelengths	24V	Wavelength #3: 0-10V	GND	NC	Wavelength #4: 0-10V
Connector #3					
All Lights requiring 3 or 4 connectors	24V	NC	GND	NC	NC
Connector #4					
Not applicable	24V	NC	GND	NC	NC

Note 1: Additional Connector may be required. See Table 4: Max Current Draw and Number of Connectors per Size (Standard Version)



M12 4-pin T-Code Bulkhead

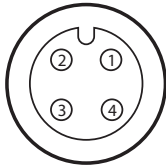
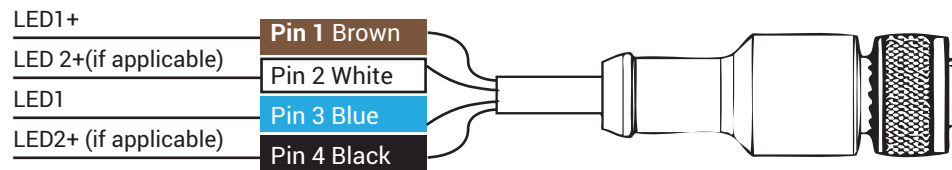

FIGURE 3: CABLE COLOR CODE, M12T CONNECTOR

Pin	Function	Wire Color
1	LED1+	Brown
2	LED2+ (if applicable)	White
3	LED1	Blue
4	LED2+ (if applicable)	Black

FIGURE 4: TXBL INTERFACE CABLE WITH AN M12 4-PIN T-CODE FEMALE CONNECTOR



See Table 1: Part Number Key for Cable Part Number by length.

Note: Common wiring configurations shown. Certain size & # of colors combinations require different wiring. Please refer to documentation supplied with product for exact wiring instructions.

TABLE 3: TXBL INTERFACE CABLE WITH AN M12 4-PIN T-CODE FEMALE CONNECTOR

M12T Wiring				
Connector #1	Pin 1	Pin 2	Pin 3	Pin 4
1 Wavelength	LED+	LED+	LED 1-	LED-
2 Wavelengths	LED+	LED 2+	LED 1-	LED 2-
3 Wavelengths	LED+	LED 2+	LED 1-	LED 2-
4 Wavelengths	LED+	LED 2+	LED 1-	LED 2-
Connector #2				
1 Wavelength				
2 Wavelengths				
3 Wavelengths	LED 3+	NC	LED 3-	NC
4 Wavelengths	LED 3+	LED 4+	LED 3-	LED 4-

ULC-2 CONTROLLER

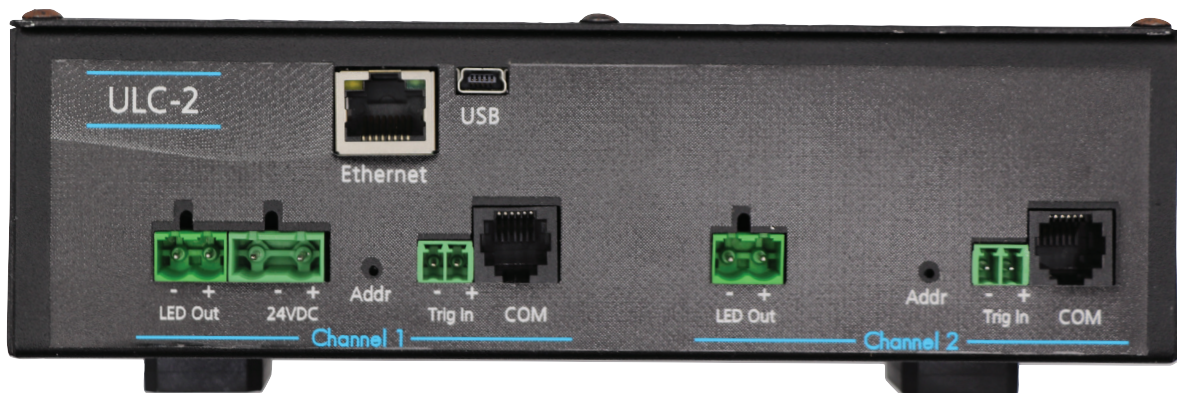



TABLE 5: ULC SETTINGS DC PER CHANNEL (AMPS) PER SIZE

YY	XX XX															
	TXBL	02	03	04	05	06	07	08	09	10	11	12	13	14	15	16
2	0.07	0.1	0.14	0.17	0.2	0.24	0.27	0.31	0.34	0.37	0.41	0.44	0.47	0.51	0.54	
3	0.1	0.15	0.2	0.25	0.31	0.36	0.41	0.46	0.51	0.56	0.61	0.66	0.71	0.76	0.81	
4	0.14	0.2	0.27	0.34	0.41	0.47	0.54	0.61	0.68	0.75	0.81	0.88	0.95	1.02	1.08	
5	0.17	0.25	0.34	0.42	0.51	0.59	0.68	0.76	0.85	0.93	1.02	1.1	1.19	1.27	1.36	
6	0.2	0.31	0.41	0.51	0.61	0.71	0.81	0.92	1.02	1.12	1.22	1.32	1.42	1.53	1.63	
7	0.24	0.36	0.47	0.59	0.71	0.83	0.95	1.07	1.19	1.3	1.42	1.54	1.66	1.78	1.9	
8	0.27	0.41	0.54	0.68	0.81	0.95	1.08	1.22	1.36	1.49	1.63	1.76	1.9	2.03	2.17	
9	0.31	0.46	0.61	0.76	0.92	1.07	1.22	1.37	1.53	1.68	1.83	1.98	2.14	2.29	2.44	
10	0.34	0.51	0.68	0.85	1.02	1.19	1.36	1.53	1.69	1.86	2.03	2.2	2.37	2.54	2.71	
11	0.37	0.56	0.75	0.93	1.12	1.3	1.49	1.68	1.86	2.05	2.24	2.42	2.61	2.8	2.98	
12	0.41	0.61	0.81	1.02	1.22	1.42	1.63	1.83	2.03	2.24	2.44	2.64	2.85	3.05	3.25	
13	0.44	0.66	0.88	1.1	1.32	1.54	1.76	1.98	2.2	2.42	2.64	2.86	3.08	3.3	3.53	
14	0.47	0.71	0.95	1.19	1.42	1.66	1.9	2.14	2.37	2.61	2.85	3.08	3.32	3.56	3.8	
15	0.51	0.76	1.02	1.27	1.53	1.78	2.03	2.29	2.54	2.8	3.05	3.3	3.56	3.81	4.07	
16	0.54	0.81	1.08	1.36	1.63	1.9	2.17	2.44	2.71	2.98	3.25	3.53	3.8	4.07	4.34	

Example

Part Number sequence: TXBL1AXXXY:

- XX = shortest dimension, YY is \geq XX.
- One unit of measurement = 25mm of active area, example: TXBL0410 is 100mm x 250mm active area
- For the TXBL1A0513, the ULC-2 setting is 1.8A maximum

Note: Color on chart corresponds to number of ULC channels needed AND number of M12 connectors needed.

ULC STROBE SETTINGS

- Max overdriving pulse duration= 1000 μ s (1ms)
- For trigger duty cycles \geq 5%
- For ULC-2 external controller, max strobe current per ULC-2 channel is 40A

Legend

- Requires (1) ULC chan (on 1 M12 connector)
- Requires (2) ULC chan (on 1 M12 connector)

Single channel ULC Strobing current = TXBLXX * TXBLYY * .028 / User-Desired Trigger Input Duty Cycle / number of colors in light

Examples:

- TXBL0508-W-U and customer desired duty cycle of 20% -- ULC Strobing current = 05 * 08 * .028 / .2 / 1 = 5.6A
- TXCBL0202-R-U and customer desired duty cycle of 5% -- ULC Strobing current = 02 * 02 * .028 / .05 / 1 = 2.2A
- TXCBL1212-B-U and customer desired duty cycle of 10% -- ULC Strobing current = 11 * 12 * .028 / .1 / 1 = 37A
- TXBL1624-RGB-U and customer desired duty cycle of 10% -- ULC Strobing current = 16 * 24 * .028 / .1 / 3 = 35.8A for each of (3) ULC channels

Note: 3 and 4 color options require more connectors.



TABLE 4: MAX CURRENT DRAW AND NUMBER OF CONNECTORS PER SIZE (-DC VERSION)

XX

TXBL	02	03	04	05	06	07	08	09	10	11	12	13	14	15	16
02	0.06														
03	0.10	0.15													
04	0.13	0.19	0.26												
05	0.16	0.24	0.32	0.40											
06	0.19	0.29	0.39	0.49	0.58										
07	0.23	0.34	0.45	0.57	0.68	0.79									
08	0.26	0.39	0.52	0.65	0.78	0.91	1.04								
09	0.29	0.44	0.58	0.73	0.87	1.02	1.17	1.31							
10	0.32	0.49	0.65	0.81	0.97	1.13	1.29	1.46	1.62						
11	0.36	0.53	0.71	0.89	1.07	1.25	1.42	1.60	1.78	1.96					
12	0.39	0.58	0.78	0.97	1.17	1.36	1.55	1.75	1.94	2.1	2.3				
13	0.42	0.63	0.84	1.05	1.26	1.47	1.68	1.89	2.1	2.3	2.5	2.7			
14	0.45	0.68	0.91	1.13	1.36	1.59	1.81	2.0	2.3	2.5	2.7	2.9	3.2		
15	0.49	0.73	0.97	1.21	1.46	1.70	1.94	2.2	2.4	2.7	2.9	3.2	3.4	3.6	
16	0.52	0.78	1.04	1.29	1.55	1.81	2.1	2.3	2.6	2.8	3.1	3.4	3.6	3.9	4.1
17	0.55	0.83	1.10	1.38	1.65	1.93	2.2	2.5	2.8	3.0	3.3	3.6	3.9	4.1	4.4
18	0.58	0.87	1.17	1.46	1.75	2.0	2.3	2.6	2.9	3.2	3.5	3.8	4.1	4.4	4.7
19	0.61	0.92	1.23	1.54	1.84	2.2	2.5	2.8	3.1	3.4	3.7	4.0	4.3	4.6	4.9
20	0.65	0.97	1.29	1.62	1.94	2.3	2.6	2.9	3.2	3.6	3.9	4.2	4.5	4.9	5.2
21	0.68	1.02	1.36	1.70	2.0	2.4	2.7	3.1	3.4	3.7	4.1	4.4	4.8	5.1	5.4
22	0.71	1.07	1.42	1.78	2.1	2.5	2.8	3.2	3.6	3.9	4.3	4.6	5.0	5.3	5.7
23	0.74	1.12	1.49	1.86	2.2	2.6	3.0	3.4	3.7	4.1	4.5	4.8	5.2	5.6	6.0
24	0.78	1.17	1.55	1.94	2.3	2.7	3.1	3.5	3.9	4.3	4.7	5.0	5.4	5.8	6.2
25	0.81	1.21	1.62	2.0	2.4	2.8	3.2	3.6	4.0	4.5	4.9	5.3	5.7	6.1	6.5
26	0.84	1.26	1.68	2.1	2.5	2.9	3.4	3.8	4.2	4.6	5.0	5.5	5.9	6.3	6.7
27	0.87	1.31	1.75	2.2	2.6	3.1	3.5	3.9	4.4	4.8	5.2	5.7	6.1	6.6	7.0
28	0.91	1.36	1.81	2.3	2.7	3.2	3.6	4.1	4.5	5.0	5.4	5.9	6.3	6.8	7.3
29	0.94	1.41	1.88	2.3	2.8	3.3	3.8	4.2	4.7	5.2	5.6	6.1	6.6	7.0	7.5
30	0.97	1.46	1.94	2.4	2.9	3.4	3.9	4.4	4.9	5.3	5.8	6.3	6.8	7.3	7.8
31	1.00	1.51	2.0	2.5	3.0	3.5	4.0	4.5	5.0	5.5	6.0	6.5	7.0	7.5	8.0
32	1.04	1.55	2.1	2.6	3.1	3.6	4.1	4.7	5.2	5.7	6.2	6.7	7.3	7.8	8.3
33	1.07	1.60	2.1	2.7	3.2	3.7	4.3	4.8	5.3	5.9	6.4	6.9	7.5	8.0	8.5
34	1.10	1.65	2.2	2.8	3.3	3.9	4.4	5.0	5.5	6.1	6.6	7.2	7.7	8.3	8.8
35	1.13	1.70	2.3	2.8	3.4	4.0	4.5	5.1	5.7	6.2	6.8	7.4	7.9	8.5	9.1
36	1.17	1.75	2.3	2.9	3.5	4.1	4.7	5.2	5.8	6.4	7.0	7.6	8.2	8.7	9.3
37	1.20	1.80	2.4	3.0	3.6	4.2	4.8	5.4	6.0	6.6	7.2	7.8	8.4	9.0	9.6
38	1.23	1.84	2.5	3.1	3.7	4.3	4.9	5.5	6.1	6.8	7.4	8.0	8.6	9.2	9.8
39	1.26	1.89	2.5	3.2	3.8	4.4	5.0	5.7	6.3	6.9	7.6	8.2	8.8	9.5	10.1
40	1.29	1.94	2.6	3.2	3.9	4.5	5.2	5.8	6.5	7.1	7.8	8.4	9.1	9.7	10.4

Example
 Part Number sequence: TXBLXXYY:
 • XX = shortest dimension, YY is ≥ XX
 • One unit of measurement = 25mm of active area: TXBL0410 is 100mm x 250mm active area
 • The TXBL0812 requires a quantity of one (1) M12A connector; Current = 2.1A

Legend

- Requires (1) M12
- Requires (2) M12
- Requires (3) M12

YY



TABLE 4: MAX CURRENT DRAW AND NUMBER OF CONNECTORS PER SIZE (STANDARD VERSION)

XX

TXBL	02	03	04	05	06	07	08	09	10	11	12	13	14	15	16	
02	0.07	0.10	0.14	0.17	0.20	0.24	0.27	0.31	0.34	0.37	0.41	0.44	0.47	0.51	0.54	
03	0.10	0.15	0.20	0.25	0.31	0.36	0.41	0.46	0.51	0.56	0.61	0.66	0.71	0.76	0.81	
04	0.14	0.20	0.27	0.34	0.41	0.47	0.54	0.61	0.68	0.75	0.81	0.88	0.95	1.02	1.08	
05	0.17	0.25	0.34	0.42	0.51	0.59	0.68	0.76	0.85	0.93	1.02	1.10	1.19	1.27	1.36	
06	0.20	0.31	0.41	0.51	0.61	0.71	0.81	0.92	1.02	1.12	1.22	1.32	1.42	1.53	1.63	
07	0.24	0.36	0.47	0.59	0.71	0.83	0.95	1.07	1.19	1.30	1.42	1.54	1.66	1.78	1.90	
YY	08	0.27	0.41	0.54	0.68	0.81	0.95	1.08	1.22	1.36	1.49	1.63	1.76	1.90	2.03	2.17
	09	0.31	0.46	0.61	0.76	0.92	1.07	1.22	1.37	1.53	1.68	1.83	1.98	2.14	2.29	2.44
	10	0.34	0.51	0.68	0.85	1.02	1.19	1.36	1.53	1.69	1.86	2.03	2.20	2.37	2.54	2.71
	11	0.37	0.56	0.75	0.93	1.12	1.30	1.49	1.68	1.86	2.05	2.24	2.42	2.61	2.80	2.98
	12	0.41	0.61	0.81	1.02	1.22	1.42	1.63	1.83	2.03	2.24	2.44	2.64	2.85	3.05	3.25
	13	0.44	0.66	0.88	1.10	1.32	1.54	1.76	1.98	2.20	2.42	2.64	2.86	3.08	3.30	3.53
	14	0.47	0.71	0.95	1.19	1.42	1.66	1.90	2.14	2.37	2.61	2.85	3.08	3.32	3.56	3.80
	15	0.51	0.76	1.02	1.27	1.53	1.78	2.03	2.29	2.54	2.80	3.05	3.30	3.56	3.81	4.07
	16	0.54	0.81	1.08	1.36	1.63	1.90	2.17	2.44	2.71	2.98	3.25	3.53	3.80	4.07	4.34

Example

Part Number sequence: TXBL1AXXYY:

- XX = shortest dimension, YY is \geq XX
- One unit of measurement = 25mm of active area: TXBL1A0410 is 100mm x 250mm active area
- The TXBL1A0812 requires a quantity of one (1) M12A connector; Current = 1.63A

Legend

Requires (1) M12

Requires (2) M12

Note: 3 and 4 color options require more connectors.



TABLE 6: WEIGHT (KG) FOR ACTIVE AREA WIDTH AND LENGTH

		XX															
YY	TXBL	02	03	04	05	06	07	08	09	10	11	12	13	14	15	16	
	02	0.2															
	03	0.3	0.3														
	04	0.3	0.3	0.4													
	05	0.3	0.4	0.4	0.5												
	06	0.4	0.4	0.5	0.6	0.6											
	07	0.4	0.5	0.5	0.6	0.7	0.8										
	08	0.4	0.5	0.6	0.7	0.8	0.8	0.9									
	09	0.5	0.6	0.6	0.7	0.8	0.9	1.0	1.1								
	10	0.5	0.6	0.7	0.8	0.9	1.0	1.1	1.2	1.3							
	11	0.5	0.6	0.7	0.9	1.0	1.1	1.2	1.3	1.4	1.5						
	12	0.6	0.7	0.8	0.9	1.0	1.1	1.3	1.4	1.5	1.6	1.7					
	13	0.6	0.7	0.8	1.0	1.1	1.2	1.3	1.5	1.6	1.7	1.8	2.0				
	14	0.6	0.8	0.9	1.0	1.2	1.3	1.4	1.6	1.7	1.8	1.9	2.1	2.2			
	15	0.7	0.8	0.9	1.1	1.2	1.4	1.5	1.6	1.8	1.9	2.1	2.2	2.3	2.5		
	16	0.7	0.8	1.0	1.1	1.3	1.4	1.6	1.7	1.9	2.0	2.2	2.3	2.5	2.6	2.8	
	17	0.7	0.9	1.1	1.2	1.4	1.5	1.7	1.8	2.0	2.2	2.3	2.5	2.6	2.8	3.0	
	18	0.8	0.9	1.1	1.3	1.4	1.6	1.8	1.9	2.1	2.3	2.4	2.6	2.8	2.9	3.1	
	19	0.8	1.0	1.2	1.3	1.5	1.7	1.9	2.0	2.2	2.4	2.6	2.7	2.9	3.1	3.3	
	20	0.8	1.0	1.2	1.4	1.6	1.8	1.9	2.1	2.3	2.5	2.7	2.9	3.0	3.2	3.4	
	21	0.9	1.1	1.3	1.4	1.6	1.8	2.0	2.2	2.4	2.6	2.8	3.0	3.2	3.4	3.5	
	22	0.9	1.1	1.3	1.5	1.7	1.9	2.1	2.3	2.5	2.7	2.9	3.1	3.3	3.5	3.7	
	23	0.9	1.1	1.4	1.6	1.8	2.0	2.2	2.4	2.6	2.8	3.0	3.2	3.4	3.6	3.8	
	24	1.0	1.2	1.4	1.6	1.8	2.0	2.3	2.5	2.7	2.9	3.1	3.3	3.6	3.8	4.0	
	25	1.0	1.2	1.5	1.7	1.9	2.1	2.3	2.6	2.8	3.0	3.2	3.5	3.7	3.9	4.1	
	26	1.0	1.3	1.5	1.7	2.0	2.2	2.4	2.7	2.9	3.1	3.4	3.6	3.8	4.1	4.3	
	27	1.1	1.3	1.6	1.8	2.0	2.3	2.5	2.8	3.0	3.2	3.5	3.7	4.0	4.2	4.4	
	28	1.1	1.4	1.6	1.8	2.1	2.3	2.6	2.8	3.1	3.3	3.6	3.8	4.1	4.3	4.6	
	29	1.1	1.4	1.6	1.9	2.2	2.4	2.7	2.9	3.2	3.5	3.7	4.0	4.2	4.5	4.7	
	30	1.2	1.4	1.7	2.0	2.2	2.5	2.8	3.0	3.3	3.6	3.8	4.1	4.4	4.6	4.9	
	31	1.2	1.5	1.7	2.0	2.3	2.6	2.8	3.1	3.4	3.7	3.9	4.2	4.5	4.8	5.0	
	32	1.2	1.5	1.8	2.1	2.4	2.6	2.9	3.2	3.5	3.8	4.1	4.3	4.6	4.9	5.2	
	33	1.3	1.6	1.8	2.1	2.4	2.7	3.0	3.3	3.6	3.9	4.2	4.5	4.7	5.0	5.3	
	34	1.3	1.6	1.9	2.2	2.5	2.8	3.1	3.4	3.7	4.0	4.3	4.6	4.9	5.2	5.5	
	35	1.3	1.6	1.9	2.3	2.6	2.9	3.2	3.5	3.8	4.1	4.4	4.7	5.0	5.3	5.6	
	36	1.4	1.7	2.0	2.3	2.6	2.9	3.3	3.6	3.9	4.2	4.5	4.8	5.1	5.5	5.8	
	37	1.4	1.7	2.0	2.4	2.7	3.0	3.3	3.7	4.0	4.3	4.6	5.0	5.3	5.6	5.9	
	38	1.4	1.8	2.1	2.4	2.8	3.1	3.4	3.8	4.1	4.4	4.7	5.1	5.4	5.7	6.1	
	39	1.5	1.8	2.1	2.5	2.8	3.2	3.5	3.8	4.2	4.5	4.9	5.2	5.5	5.9	6.2	
	40	1.5	1.9	2.2	2.5	2.9	3.2	3.6	3.9	4.3	4.6	5.0	5.3	5.7	6.0	6.4	

Part Number sequence:

TXBLXXYY

- XX = shortest dimension,
- YY is \geq XX

- One unit of measurement = 25mm of active area.

Example Active area/weight:

- TXBL0816 = (08) *25mm X (16) *25mm = 200x400mm, weight is 1.6 kg.



**FIGURE 5:
RELATIVE INTENSITY - WHITE SPECTRAL DATA**

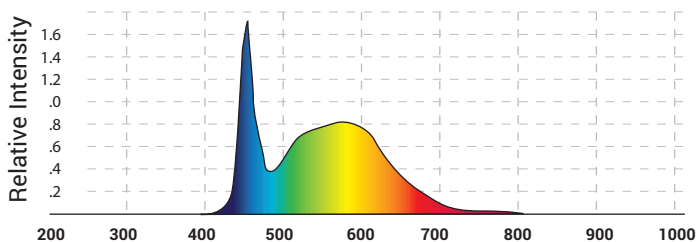

**FIGURE 6:
RELATIVE INTENSITY - RED SPECTRAL DATA**

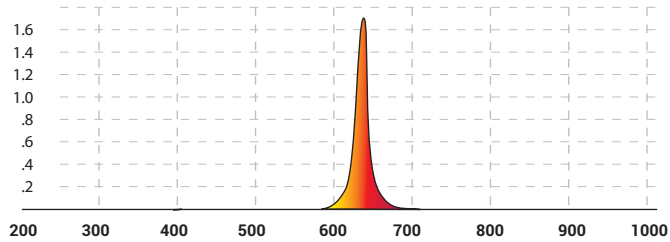

**FIGURE 7:
RELATIVE INTENSITY - GREEN SPECTRAL DATA**

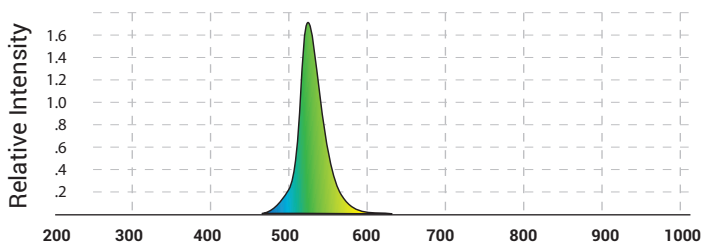

**FIGURE 8:
RELATIVE INTENSITY - BLUE SPECTRAL DATA**

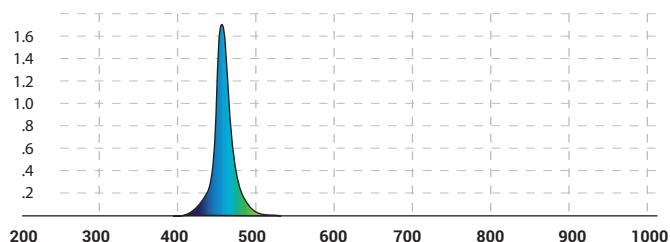

**FIGURE 9:
RELATIVE INTENSITY - IR850 SPECTRAL DATA**

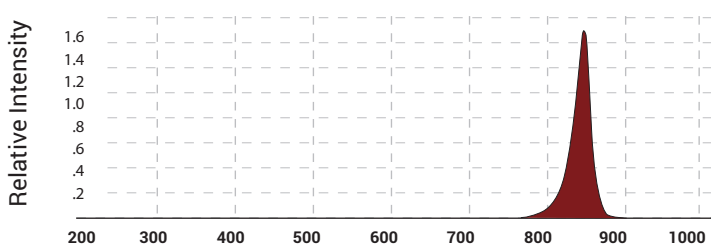

**FIGURE 10:
RELATIVE INTENSITY - IR940 SPECTRAL DATA**

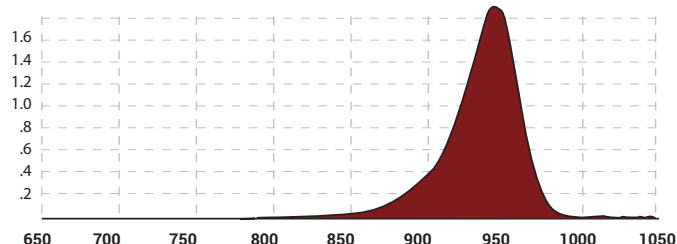

**FIGURE 11:
TXBL UNIFORMITY PROFILE**



Intensity = 86,000 Lux (263W/m²)

TXBL / TXCBL Mechanical Drawings

FIGURE 12: TXBL / TXCBL DIMENSIONS TOP VIEW



TX Series
Back Light

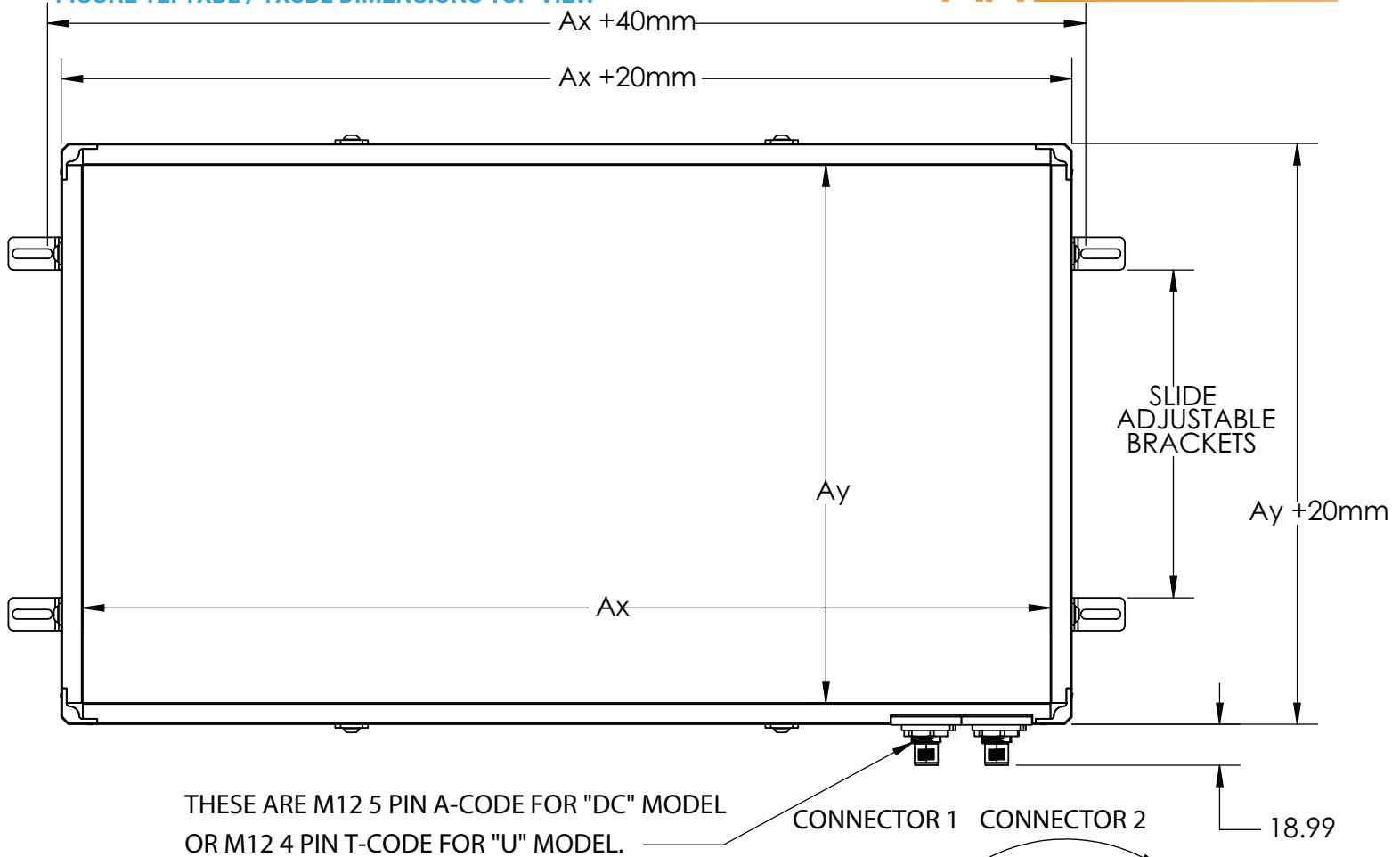
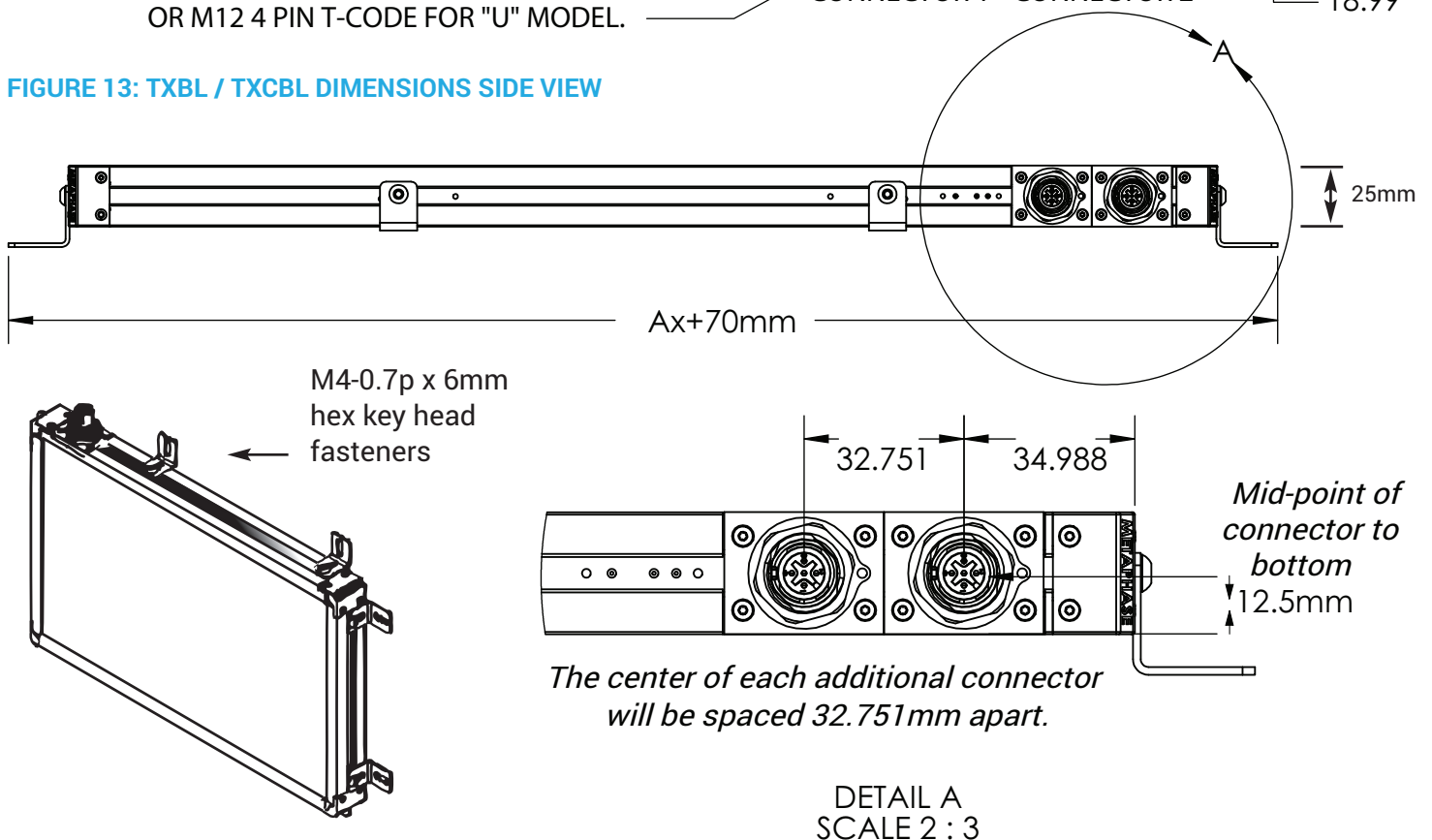

FIGURE 13: TXBL / TXCBL DIMENSIONS SIDE VIEW



DETAIL A
SCALE 2 : 3



For nearly two decades, Metaphase Technologies has been developing products that implement “The Quality of Light” through engineering and manufacture of cutting-edge LED illuminators for machine vision, military, and specialty lighting applications.

We're proud of our demonstrated expertise engineering flexible lighting solutions that have facilitated integration into thousands of vision systems designs.

Throughout the world, Metaphase clients enjoy the enhanced automation and image capture benefits of our patent-pending breakthroughs in uniform diffuse high brightness and ultra-brightness LED illumination.

First to implement built-in constant current drivers across multiple product lines, Metaphase continues to synergize cutting-edge LED lighting & control technologies that streamline innovation and increases return on investment.

Made in the USA for nearly 30 years, our versatile designs are continuously updated to incorporate the latest advances in LEDs, thermal management, optics, and electronic technologies to meet the challenging needs of today's global automation and scientific marketplace.

Contact us to see how Metaphase can help with your cutting-edge lighting needs.



200 Rittenhouse Circle, West Unit 7, Bristol, PA 19007 USA
+1-215-639-8699 www.metaphase-tech.com