

# L300G2

## Linear Light CONNECT-A-LIGHT

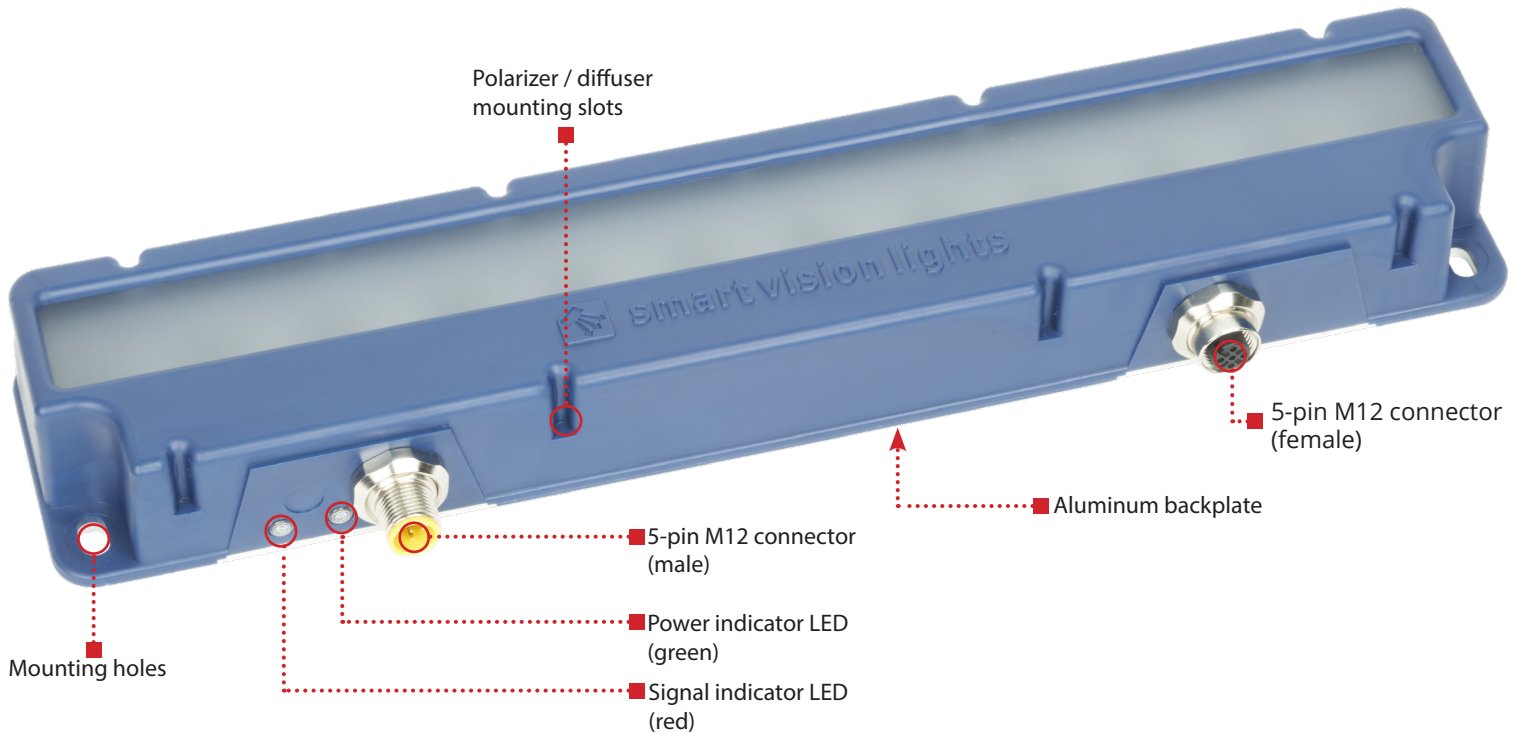

The L300G2 is a linear light featuring an integrated Multi-Drive™ driver that can produce up to 390,000 lux. NPN or PNP triggers can be used to control the light for either OverDrive™ or continuous operation. Light intensity can be controlled via 1 - 10 VDC analog intensity line or remotely using SmartVisionLink™\*. The L300G2 can be daisy-chained with up to six lights in series using a standard 5-pin M12 jumper cable.

### L300G2 HIGHLIGHTS

Warranty <b>10 YEAR</b>	Tested <b>IEC 62471</b>	Compliant <b>CE ROHS</b>	Rated <b>IP 50</b>	Connector <b>5-PIN M12</b>
--------------------------------	--------------------------------	---------------------------------	---------------------------	-----------------------------------

- ✓ SmartVisionLink™-enabled for easy intensity adjustment.
- ✓ Daisy-chain up to six L300G2 linear lights using a standard 5-pin M12 jumper cable
- ✓ Multi-Drive™ provides both OverDrive™ and continuous mode functionality.
- ✓ Built-in status indicators
- ✓ Lowest profile full-sized linear light



\*SmartVisionLink™ requires purchase of the BTM-1000 bluetooth module.

REV 04/21/22

## SPECIFICATIONS

	Continuous Operation	OverDrive Operation
Electrical Input	24 VDC +/- 5%	
Input Current	Max. 850 mA	Peak 6 A during strobe
Input Power	Max. 20 W	Peak 144 W during strobe
PNP Trigger	2 mA @ 4VDC   7 mA @ 12VDC   13.4 mA @ 24VDC	
NPN Trigger	12 mA @ Common (0VDC)	
Trigger Input	PNP > +4 VDC (24 VDC max.) to activate <b>or</b> NPN ≥ GND <1VDC to activate ( <b>not both</b> )	
Mode Control	Connect pin 5 to 1-10 VDC (10 - 100% output); 24 VDC (Max)	Connect pin 5 to GND (See wiring configuration for more information)
Strobe Duration	Min. 10 μs   Max. ∞	Min. 10 μs   Max. 50 ms
Strobe Frequency	Max 4 kHz or 1 / Duty Cycle as calculated, whichever is less. <sup>1</sup>	
Strobe Trigger Latency	6 μs	6 μs
Duty Cycle	Not Applicable	Max 10% <sup>1</sup>
Power Indicator	Turns green when powered up	
Status Indicators	Strobe indicator will turn red when on	
Analog Intensity	The output is adjustable from 10% - 100% of intensity limit by a 1 - 10 VDC signal. Jumpering pin 5 to pin 1 will provide maximum intensity. Intensity can be remotely adjusted via SmartVisionLink™ <sup>2</sup>	
Connection	5-pin M12 connector	
Operating Temperature	-10° to 40° C (14° to 104° F)   RH max 80% non-condensing humidity	
Storage Temperature	-20° to 70° C (-4° to 158° F)   RH max 80% non-condensing humidity	
IP Rating	IP50	
Weight	~370 g   ~.81 lb	
Compliances	CE, IEC 62471, RoHS	
Warranty	10 years <sup>3</sup>	

<sup>1</sup>See page 6 for more information

<sup>2</sup>SmartVisionLink™ requires the purchase of the BTM-1000 bluetooth module, sold separately, and the SmartVisionLink™ app, free to download on the Apple App and Google Play stores.

<sup>3</sup>See SmartVisionLights.com/warranty for details.

## WIRING CONFIGURATION

### CONTINUOUS OPERATION MODE

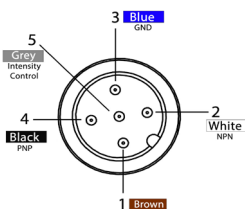

Pin layout for light (Male Connector)

Pins	Function	Signal	Wire Color
1	Power In	+24 VDC	BROWN
2	NPN	Sinking Signal	WHITE
3	GND	Ground	BLUE
4	PNP	Sourcing Signal	BLACK
5	Intensity Control	1-10 VDC	GREY

For maximum intensity, it is possible to tie pin 5 to pin 1 at +24VDC.

For continuous mode: PNP (pin 4) can be tied to +24 V DC (pin 1) **or** NPN (pin 2) can be tied to Ground (pin 3).

For proper light function, apply either a PNP or NPN signal, **not both**.

Failure to supply light with correct input current will result in inconsistent lighting behavior.

(see Product Specifications for requirements)

### OVERDRIVE OPERATION MODE

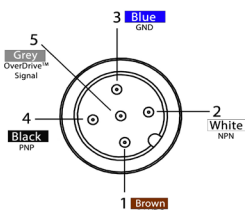

Pin layout for light (Male Connector)

Pins	Function	Signal	Wire Color
1	Power In	+24 VDC	BROWN
2	NPN	Sinking Signal	WHITE
3	GND	Ground	BLUE
4	PNP	Sourcing Signal	BLACK
5	OverDrive™ Signal	Ground	GREY

To enable OverDrive™ mode, tie pin 5 to pin 3.

Failure to supply light with correct input current will result in inconsistent lighting behavior.

(see Product Specifications for requirements)

## LENS OPTICS

### NARROW (Standard)

Narrow, 10° angle-cone lenses are standard. Standard lenses create a narrow beam of illumination and are used for long working distances.



### LINE

Line, with a 10° width and a 50° fan angle, projects a thin, narrow beam of illumination.

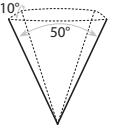

### WIDE

Wide, 30° angle-cone lenses create a large area of illumination. They create a floodlight effect and can be used for short working distances.



## LIGHTING PATTERNS

The L300G2 is recommended to be used at a working distance between 300 mm to 2000 mm. Illuminance values taken on white light - 5700K

### Standard (10°) lighting patterns

Illuminance vs. Working Distance

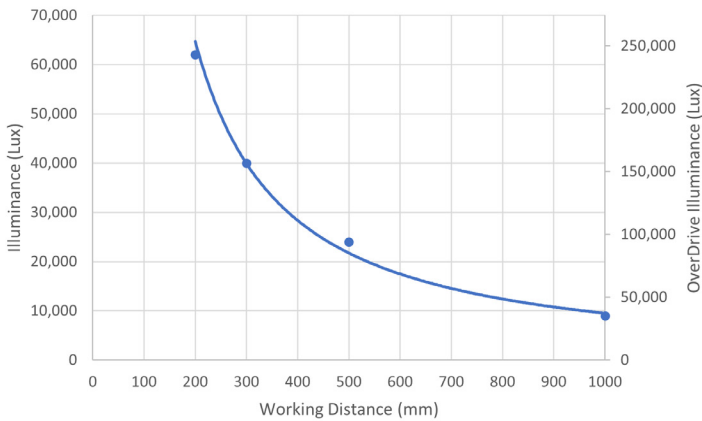

Beam Size at 80% Max Intensity vs. Working Distance

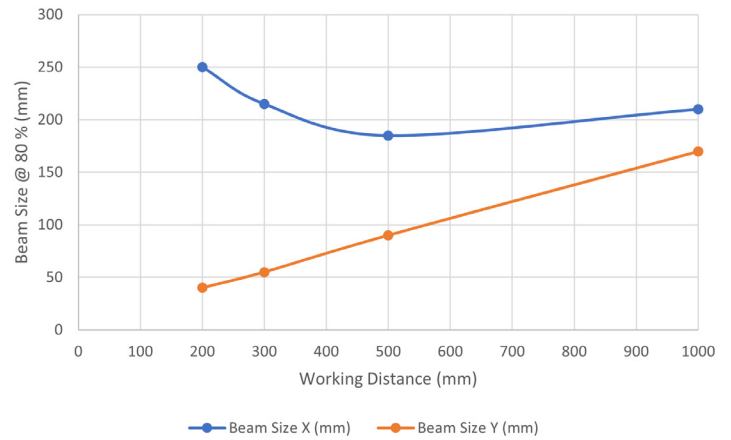

### Wide (30°) lighting patterns

Illuminance vs. Working Distance

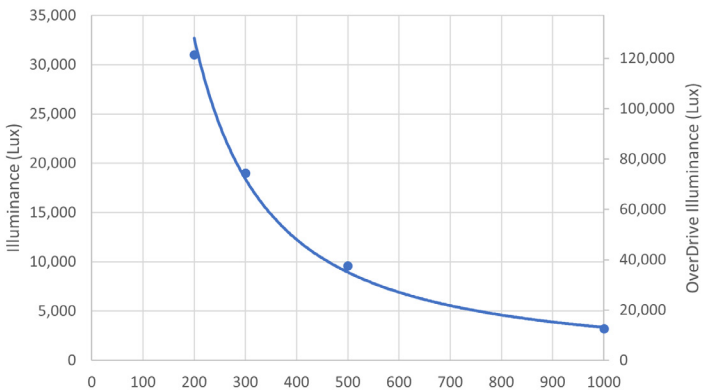

Beam Size at 80% Max Intensity vs. Working Distance

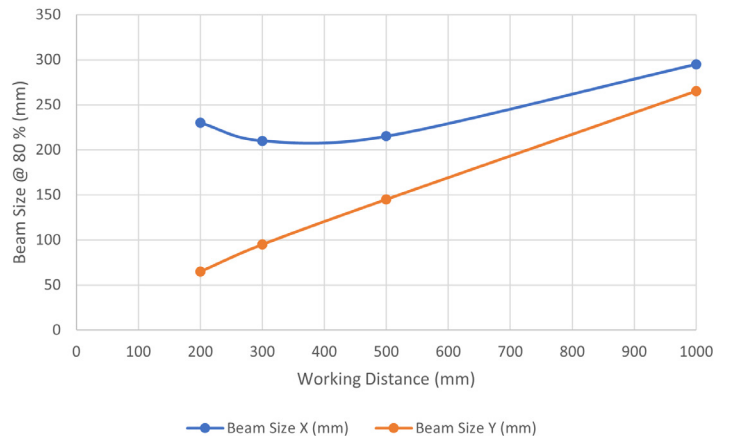

## LIGHTING PATTERNS (continued)

### Line (10° x 50°) lighting patterns

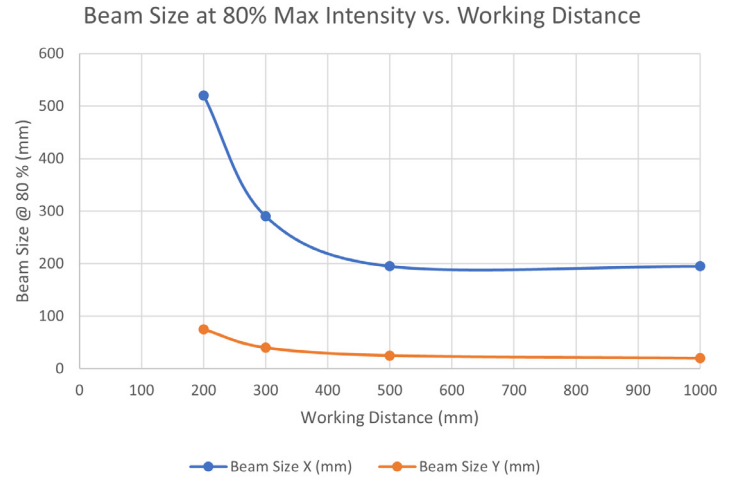
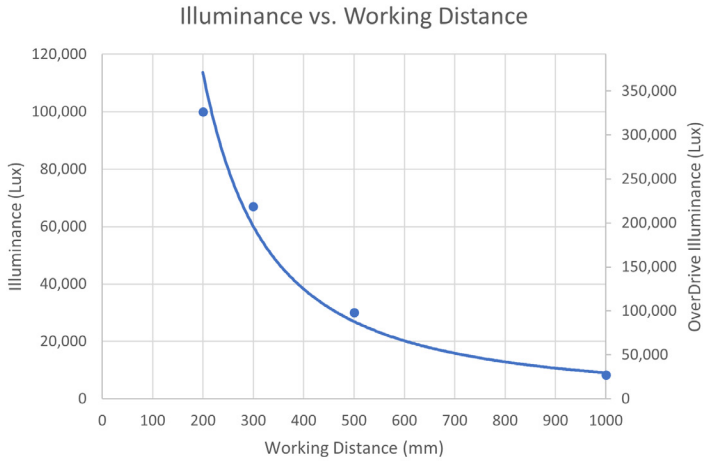

## BEAM PATTERNS

The L300G2 is recommended to be used at a working distance between 300 mm to 2000 mm. Beam patterns taken on white light - 5700K

### Standard (10°) beam patterns

Grid set to 75 mm

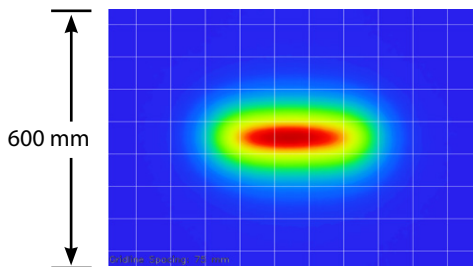

300 mm working distance

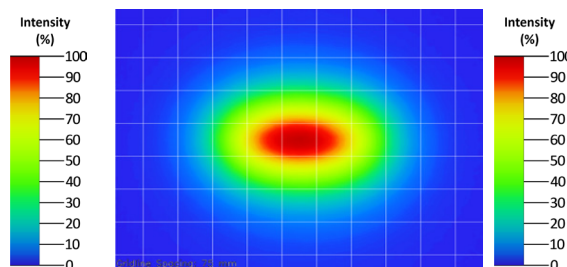

500 mm working distance

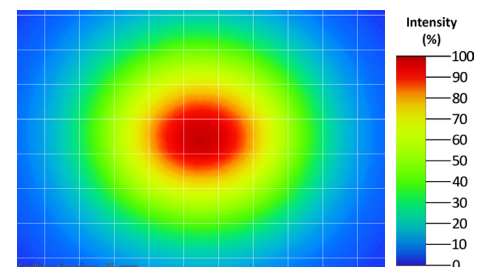

1000 mm working distance

### Wide (30°) beam patterns

Grid set to 75 mm

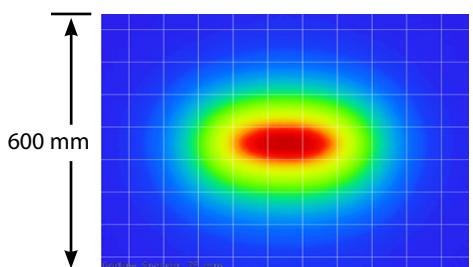

300 mm working distance

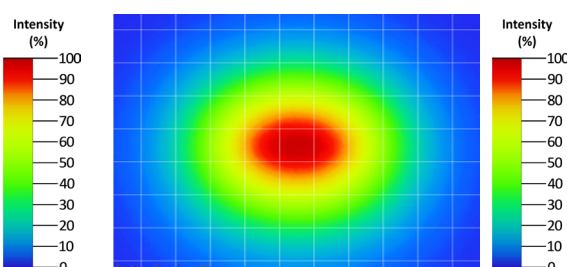

500 mm working distance

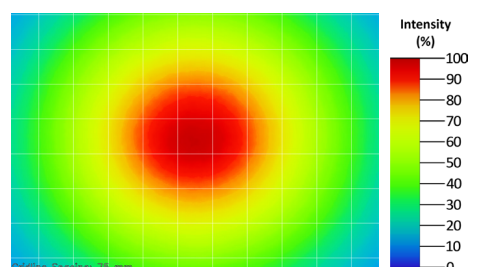

1000 mm working distance

## BEAM PATTERNS (continued)

Line (10° x 50°) beam patterns  
Grid set to 75 mm

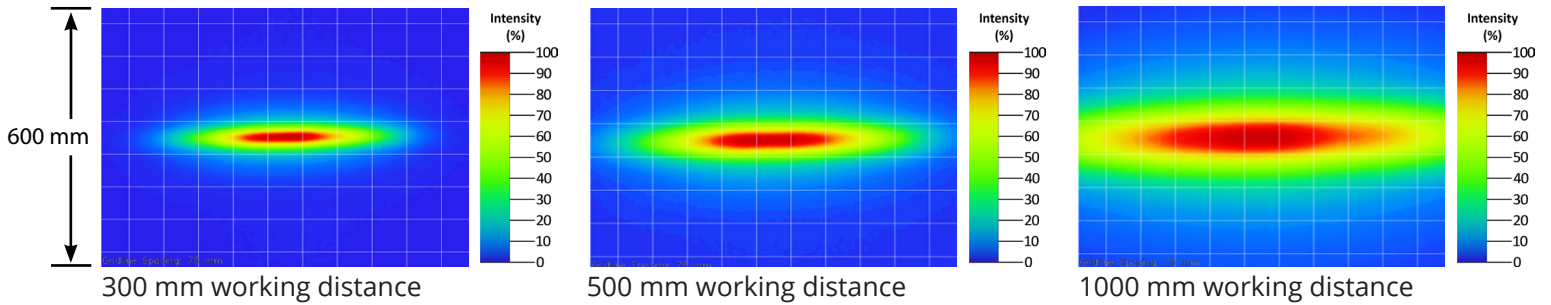

## EYE SAFETY

According to IEC 62471:2006. Full documentation available upon request with purchase of product.

### Notice

**Exempt Group:** No photobiological hazard to eyes or skin even for continuous, unrestricted use. Applicable for wavelengths 625, 850, 940, 1050, 1200, 1300, 1450, 1550, and 1650.

### Caution

**Risk Group 1:** Possibly hazardous optical radiation emitted from this product. Do not stare at operating lamp. May be harmful to eyes. Safe for most applications except prolonged exposure. Applicable for wavelengths 470, 505, 530, and WHI.

### Warning

**Risk Group 2:** UV emitted from this product. Eye or skin irritation may result from exposure. Use appropriate shielding. Does not pose optical hazard if aversion responses limit exposure. Applicable for wavelength 365 and 395.

## ILLUMINATION

The L300G2 works best for:

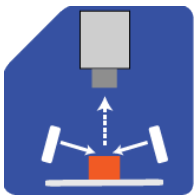

Dark Field

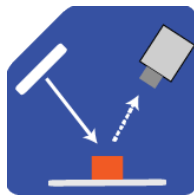

Bright Field

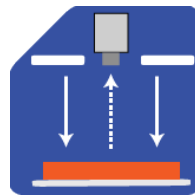

Direct Lighting

## DAISY-CHAIN LIGHTS

L300G2 Series of lights requires the use of a standard 5-pin M12 jumper cable to effectively parallel up to six L300 lights.

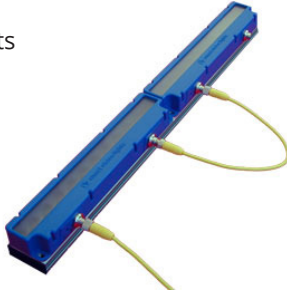

There is consistent spacing between LEDs as lights are connected together.

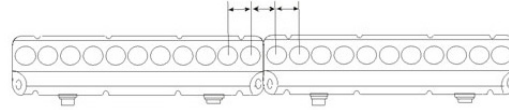

## DUTY CYCLE

**This section applies only if light is in OverDrive™ strobe mode.**

The Duty Cycle (D) is related to the Strobe Time (ST) and Rest Time (RT).

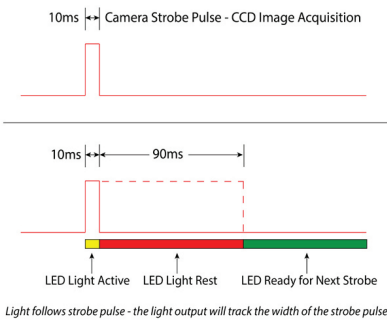

### Calculating Rest Time

$$RT = \frac{ST}{D} - ST$$

RT = Rest Time  
ST = Strobe Time  
D = Duty Cycle

#### Example

$$90 \text{ ms} = \frac{10 \text{ ms}}{.1} - 10 \text{ ms}$$

Rest Time is 90 ms for 10 ms Strobe Time

### Calculating Strobe Rate

$$SR = \frac{D}{ST}$$

SR = Strobe Rate (strokes per second)  
ST = Strobe Time (seconds)  
D = Duty Cycle

#### Example

$$1000 = \frac{0.1}{0.0001}$$

Strobe Rate is 1000 strokes per second

### Calculating Duty Cycle

$$D = ST \times SR$$

SR = Strobe Rate (strokes per second)  
ST = Strobe Time (seconds)  
D = Duty Cycle

#### Example

$$0.1 = 0.0001 \times 1000$$

Duty Cycle is 10% (0.1)

**Maximum Duty Cycle for OverDrive™ light is 10% (0.1)**

**Maximum Strobe Frequency is 1/ calculated duty cycle or 4,000 strokes per second, whichever is less.**

## MULTI-DRIVE™

Multi-Drive provides both continuous and OverDrive™ modes from a single integrated driver. Users can select the lighting mode via the input wiring configuration. With OverDrive, the light can be strobed at up to 10 times the intensity\* of continuous mode.

\*See lighting section for more information on this light's OverDrive values.



## SAFESTROBE™

SafeStrobe™ is a unique technology that applies safe working parameters to ensure high current LEDs are not damaged by driving them beyond their limits, such as maximum strobe time or duty cycle. This is especially beneficial for overdriving our high current LEDs.

## SMARTVISIONLINK™

The L300G2 is SmartVisionLink™-enabled and is designed so intensity can be adjusted using the SmartVisionLink™ app.

SmartVisionLink™ provides a way for a light to communicate with an app on a mobile device or tablet. This technology allows users to adjust the intensity of the light in both continuous operation and OverDrive™ strobe mode. By connecting the BTM-1000 Bluetooth module to a light that is SmartVisionLink™-enabled, a user can adjust parameters for the light. The SmartVisionLink™ app is available free to download in the Apple App and Google Play Stores.

Learn more at [SmartVisionLights.com/SmartVisionLink](http://SmartVisionLights.com/SmartVisionLink)

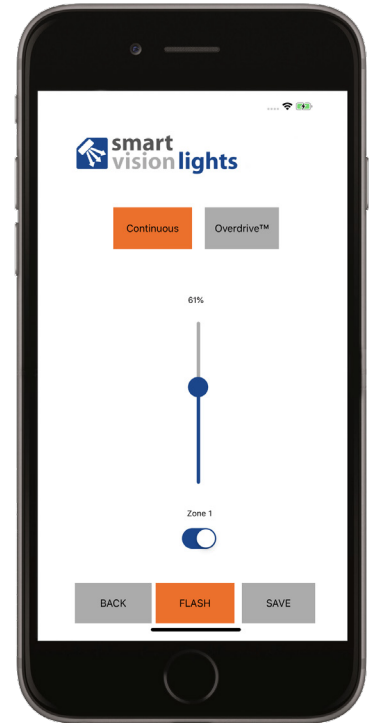

## CONNECTING A BTM-1000

The BTM-1000 can be connected directly to a light or attached to a jumper cable that is connected to a light. Once the light's intensity is set to a desired level, the BTM-1000 can be removed from the light or cable.

The pigtail end of the BTM-1000 is connected directly to the light or to the cable attached to the light - sold separately.



\*For reference only. Diagram not to scale.

## PART NUMBER GUIDE

**L300G2**



**COLOR:**



**LENS:**

Leave blank for Standard (Narrow 10°)

W = Wide (30°)

L = Line (10° x 50°)

**LINEAR POLARIZER:**

Leave blank for none

LPI = Factory Installed

### Part Number Examples

**L300G2-625** L300G2, 625 nm Red Wavelength, Standard (10° Narrow) lenses

**L300G2-WHI-L** L300G2, White Wavelength, Line Lenses

**L300G2-470-W-LPI** L300G2, 470 nm Blue Wavelength, Wide Lenses, Linear Polarizer Installed.



This light is available in our SWIR LEDs.



*Line lens optic not available for UV wavelengths.  
Additional wavelengths and lens options available upon request.*

## ACCESSORIES

### Power Cables



Length	Part Number
5 m	5PM12-5
10 m	5PM12-10
15 m	5PM12-15

### Jumper Cables (Daisy Chain)



Length	Part Number
300 mm	5PM12-J300
1000 mm	5PM12-J1000
2000 mm	5PM12-J2000

### Mount



Description	Part Number
3-Axis Pan and Tilt Mount	PB300-M5

### Mounting Rails



Length	Part Number
300 mm	LEXT300
600 mm	LEXT600
900 mm	LEXT900
1200 mm	LEXT1200
Custom sizes available	

### Diffuser



Description	Part Number
Diffuser Kit	L300-DKIT

### Linear Polarizer



Description	Part Number
Linear Polarizer Kit	L300-LP

### SmartVisionLink™



Part Number	Description
BTM-1000	Bluetooth Module

## PRODUCT DRAWINGS

\*CAD files available on our website  
Drawings are in mm

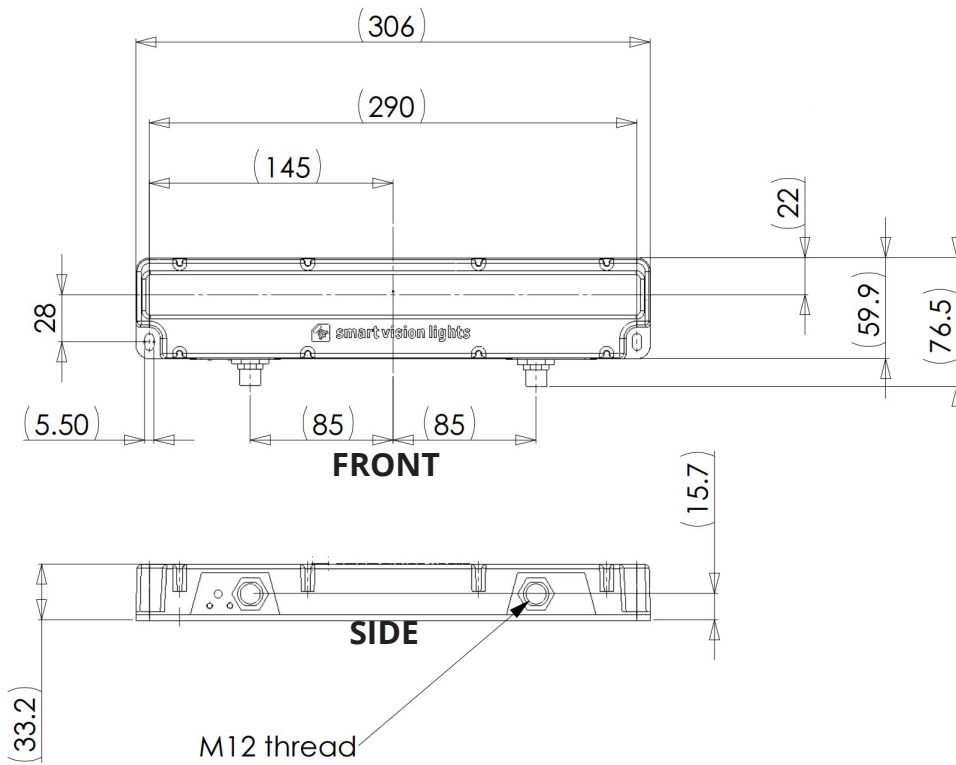

## GLOSSARY

This glossary covers all Smart Vision Lights product families; some content in this section may not apply to this specific light.

### TERMINOLOGY

**Continuous Operation** The light stays on continuously.

**OverDrive™** Integrated driver that produces a high-current strobe to the LEDs to drive them beyond their nominal continuous operation output.

**Multi-Drive™** Integrated driver that combines continuous operation and OverDrive™ strobe mode

**NanoDrive™** Integrated driver that provides fast switching where the light can go from off to on in less than 500 ns.

**Built-in Driver** The driver contained within the light that controls the current to the LEDs and provides PNP, NPN, and analog dimming controls.

**SmartVisionLink™** Integrated feature that enables lighting control through the Bluetooth module and app.

**Camera to Light** Connect the light directly to the camera, without the need for additional controllers or equipment.

**Polarizers** Filters that reduce reflections on specular surfaces.

**Diffusers** Widens the angle of emission by scattering light in all directions.

**Pattern Area Lighting** Modulated lighting pattern placed over a backlight's surface used to enhance defect detection on transparent and glossy surfaces

**SafeStrobe** Limiter to keep the light in safe working parameters.

**Direct Connect** Connect lights in a series without the use of cables.

**Daisy-Chain** Connect lights in a series with the use of cables.

### TYPES OF ILLUMINATION

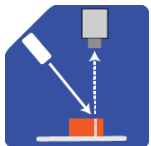

Projector

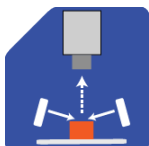

Dark Field

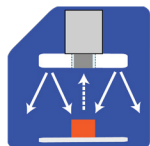

Radial



Bright Field

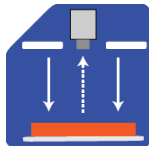

Direct

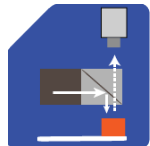

Axial

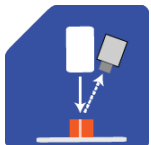

Line

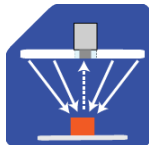

Diffuse Panel

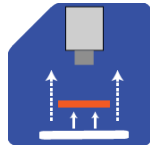

Backlight

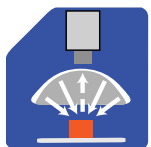

Dome  
"Light Tent"

### COMMON COLOR / WAVELENGTHS LEGEND

Wavelengths options range from 365 nm to 1650 nm.\*  
Additional wavelengths available for many light families.

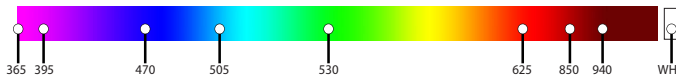

\*See Part Number section for **this light's** available standard wavelengths.



Shortwave Infrared LEDs are available in 1050 nm, 1200 nm, 1300 nm, 1450 nm, 1550 nm, and 1650 nm.\*

\*Check Part Number section to see if **this light** is available in SWIR wavelengths.



ISO 9001:2015 Certified QMS