



smart  
vision lights

# ODSX30 (N4) PROX SERIES SPOT LIGHT

LONG DISTANCE | OVERDRIVE™

## P R O D U C T D A T A S H E E T

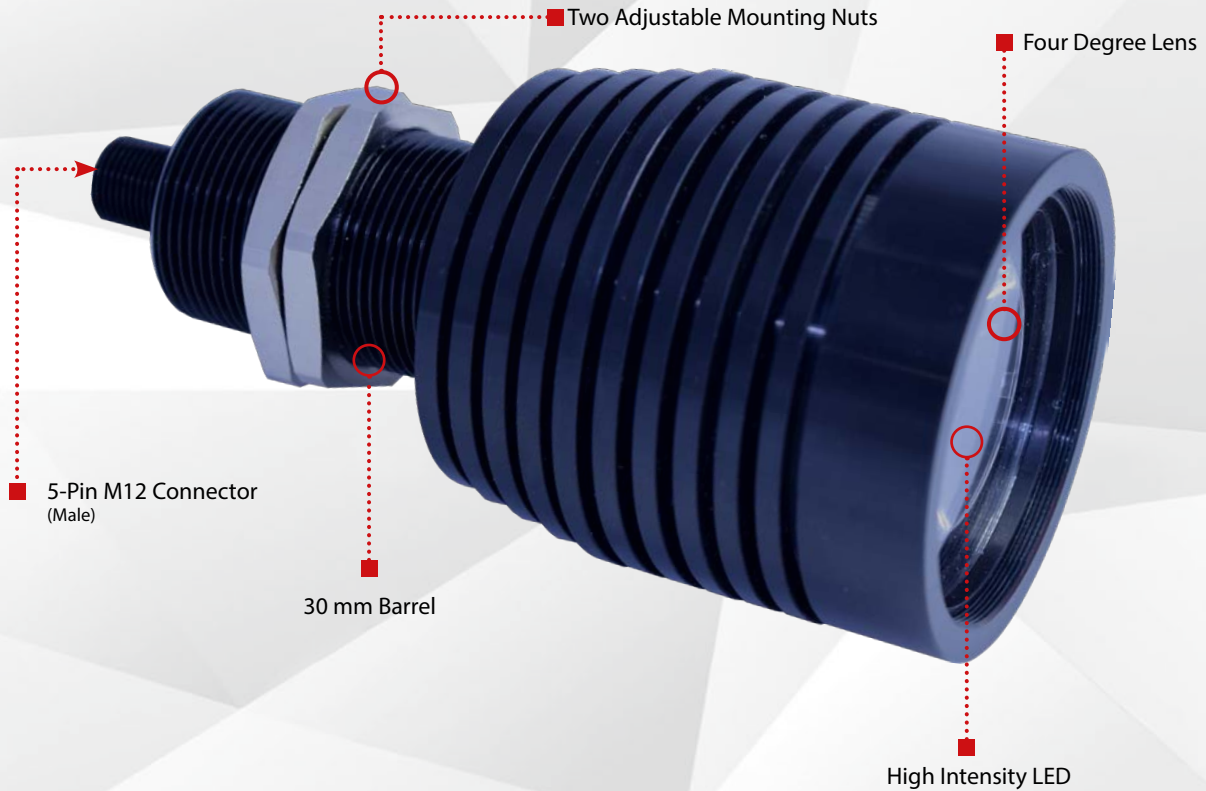

Warranty	Compliant	Compliant	Rated	Connector
<b>10</b> YEAR	<b>IEC</b> 62471	<b>CE</b> RoHS	<b>IP</b> <b>50</b>	<b>5 PIN</b> <b>M12</b>

### PRODUCT HIGHLIGHTS

- ✓ OverDrive™ — Up to 2.5 times brighter than a standard SX30 (N4) Prox Light
- ✓ Narrow, 4 degree lens allows for a long, tightly focused beam of light
- ✓ Built-in driver, no external wiring needed
- ✓ PNP and NPN strobe input
- ✓ 5-pin M12 quick connect



## PRODUCT SPECIFICATIONS

Electrical Input	24 V DC +/- 5%
Input Current	Max. 0.5 A
Wattage	Max. 12 W
Strobe Input	PNP > +4 V DC or greater to activate   NPN > GND (<1 V DC) to activate
PNP Line	4 mA @ 4 V DC   10 mA @ 12 V DC   20 mA @ 24 V DC
NPN Line	15 mA @ Ground (0VDC)
Duty Cycle	Max. 10%
Strobe/Pulse Time	Max. 5000 SPS (Strobes Per Second)   Max. Single Pulse = 125 ms
Red Indicator LED	LED Strobe Indicator ON = Light Active
Green Indicator LED	ON = Power
Analog Intensity	The output is adjustable from 10–100% of brightness by a 1–10 V DC signal. (Jumpering pin 5 to pin 1 will provide maximum intensity)
Connection	5-pin M12 connector
Ambient Temperature	-18°–40° C (0°–104° F)
IP Rating	IP50
Weight	~320g

## WIRING CONFIGURATION

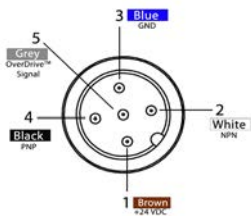

Pin layout for light (Male Connector)

Pins	Function	Signal	Wire Color
1	Power In	+24 V DC	BROWN
2	NPN	Sinking Signal	WHITE
3	GND	Ground	BLUE
4	PNP	Sourcing Signal	BLACK
5	OverDrive™ Signal	1–10 V DC	GREY*

\* Some cables use green/yellow for pin 5

If Analog 1-10 V DC is not used to control light intensity, analog input must be connected to +V DC (24 V DC) – Jumper pin 5 to pin 1

## PRODUCT DRAWING

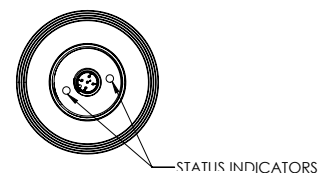
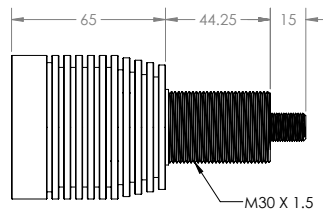
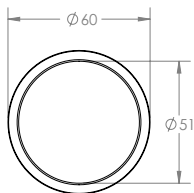

CAD files available on our website. Dimensions are in mm.

## ILLUMINATION

ODSX30 (N4) series of Linear Lights works best for:

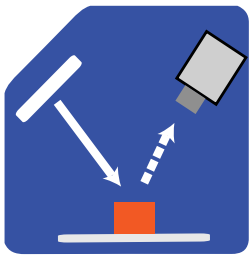

Bright Field

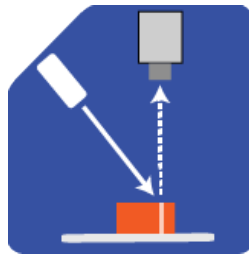

Projector

## DUTY CYCLE (OVERDRIVE™ MODE ONLY)

The Duty Cycle (D) is related to the Strobe Time (ST) and Rest Time (RT).

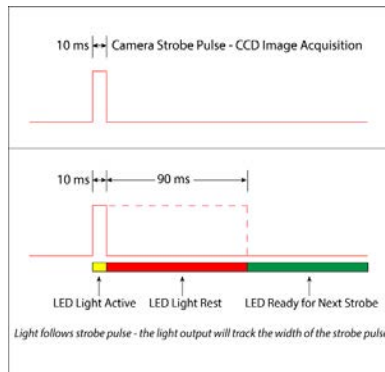

Calculating Rest Time

$$RT = \frac{ST}{D} - ST$$

RT = Rest Time  
ST = Strobe Time  
D = Duty Cycle

Example

$$RT = \frac{10 \text{ ms}}{.1} - 10 \text{ ms} = 90 \text{ ms}$$

Rest Time is 90 ms for 10 ms Strobe Time

Maximum Duty Cycle for OverDrive™ light is 10% (0.1)

## LIGHT PATTERNS

Smart Vision Lights recommends the ODSX30 (N4) be used at a working distance between 500 mm to 4000 mm.

Illumination measurement taken on White Light – 6500 K

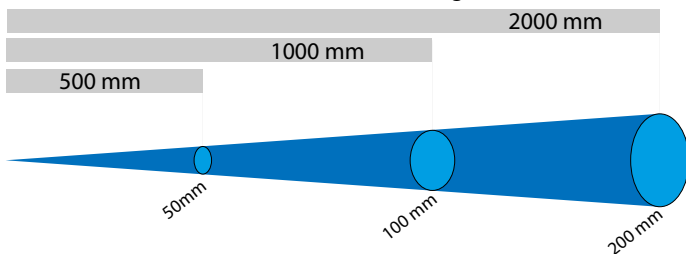

### LIGHTING PATTERN FOR THE ODSX30 (N4) with 4° (narrow) Lenses

Working Distance mm (inches)	Pattern (80% - 100% measured intensity) mm (inches)
500 mm (19.7")	50 mm (~2")
1000 mm (39.4")	100 mm (~3.9")
2000 mm (78.8")	200 mm (~7.8")

Typical Output Performance	Illumination (Lux)
Distance = 500 mm	125,000
Illumination measurement taken on White Lights – 6500K	

The ODSX30 (N4) produces a uniform light pattern.

(Grid set to 25 mm x 25 mm)

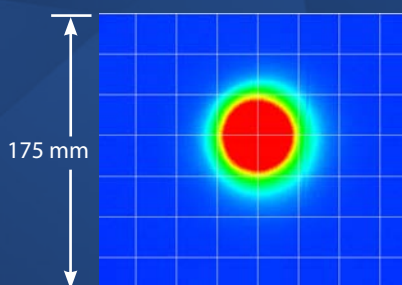

Working Distance: 500 mm

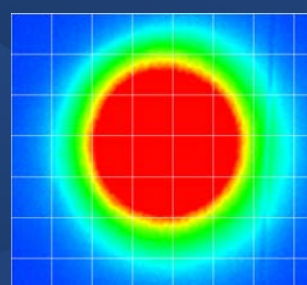

Working Distance: 1000 mm

## PART NUMBER

ODSX30 –    – N4

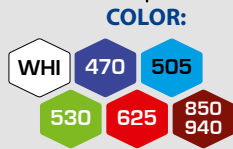

Additional wavelengths options available upon request.  
UV wavelengths not available.

### Part Number Examples:

ODSX30-625-N4 ODSX30, 625 Red Wavelength,  
Narrow 4 Degree Lens



This light is available in our SWIR LEDs  
(1050 nm, 1200 nm, 1300 nm, 1450 nm, 1550 nm)

## MOUNTING

Two M30 nuts for mounting are included with the light.

Example of the ODSX30 (N4) shown using the Slotted Right Angle mount (Part Number: PB30-M3).

See accessories for additional mounting options.

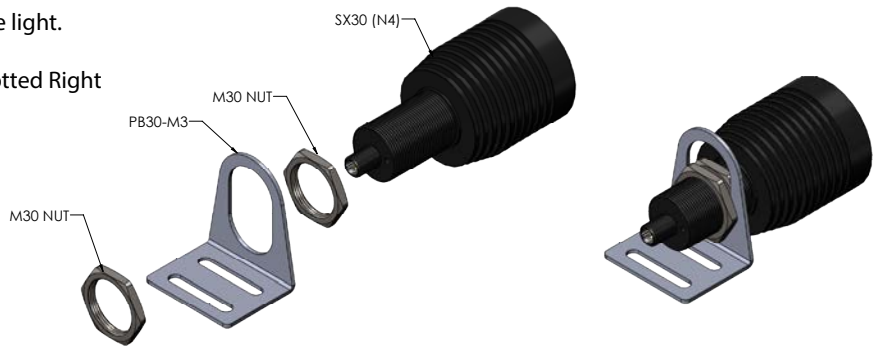

## EYE SAFETY



According to IEC 62471:2006. Full documentation upon request.

### Notice

**Exempt Group:** No photobiological hazard to eyes or skin even for continuous, unrestricted use. Applicable for wavelengths: 625, 850, and 940.

### Caution

**Risk Group 1:** Possibly hazardous optical radiation emitted from this product. Do not stare at operating lamp. May be harmful to eye. Safe for most applications except prolonged exposures. Applicable for wavelengths: 470, 505, 530, and WHI.

# ACCESSORIES

Power Cables	
	
Lengths	Part Number
5 m	5PM12-5
10 m	5PM12-10
15 m	5PM12-15

Mount	
	
Description	Part Number
Swivel Mount	PB30-M1

Mount	
	
Description	Part Number
Slotted Block Mount	PB30-M2

Mount	
	
Description	Part Number
Slotted Right Angle	PB30-M3

Mount	
	
Description	Part Number
Blot-on Block Mount	PB30-M6

# GLOSSARY

This glossary covers all Smart Vision Lights product families; some content in this section may not apply to this specific light.

## TERMINOLOGY

**OverDrive™** Lights include an integrated high-pulse driver for complete LED light control. OverDrive™ light part numbers start with OD.

**Continuous Operation** Light stays on continuously.

**Multi-Drive™** Combines continuous operation and OverDrive™ strobe (high-pulse operation) mode into one easy-to-use light.

**Built-in Driver** The built-in driver allows full function without the need of an external controller.

**Camera to Light** Connecting the light directly to the camera, without the need for additional controllers or equipment.

**Polarizers** Filters that reduce reflections on specular surfaces.

**Diffusers** Used to widen the angle of light emission, reduce reflections, and increase uniformity.

## TYPES OF ILLUMINATION

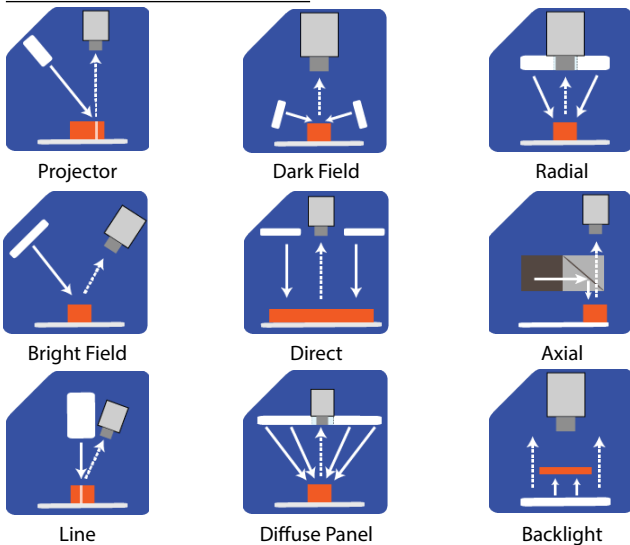

## COLOR/WAVELENGTHS LEGEND

Wavelengths options range from 365 nm to 1550 nm. \*  
Additional wavelengths available for many light families.

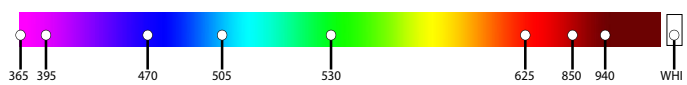

\*See Part Number section for **this light's** available standard wavelengths.



Shortwave Infrared LEDs are available in 1050 nm, 1200 nm, 1300 nm, 1450 nm, and 1550 nm.