



smart
vision lights

SX30 (N4) PROX SERIES SPOT LIGHT

LONG DISTANCE

P R O D U C T D A T A S H E E T

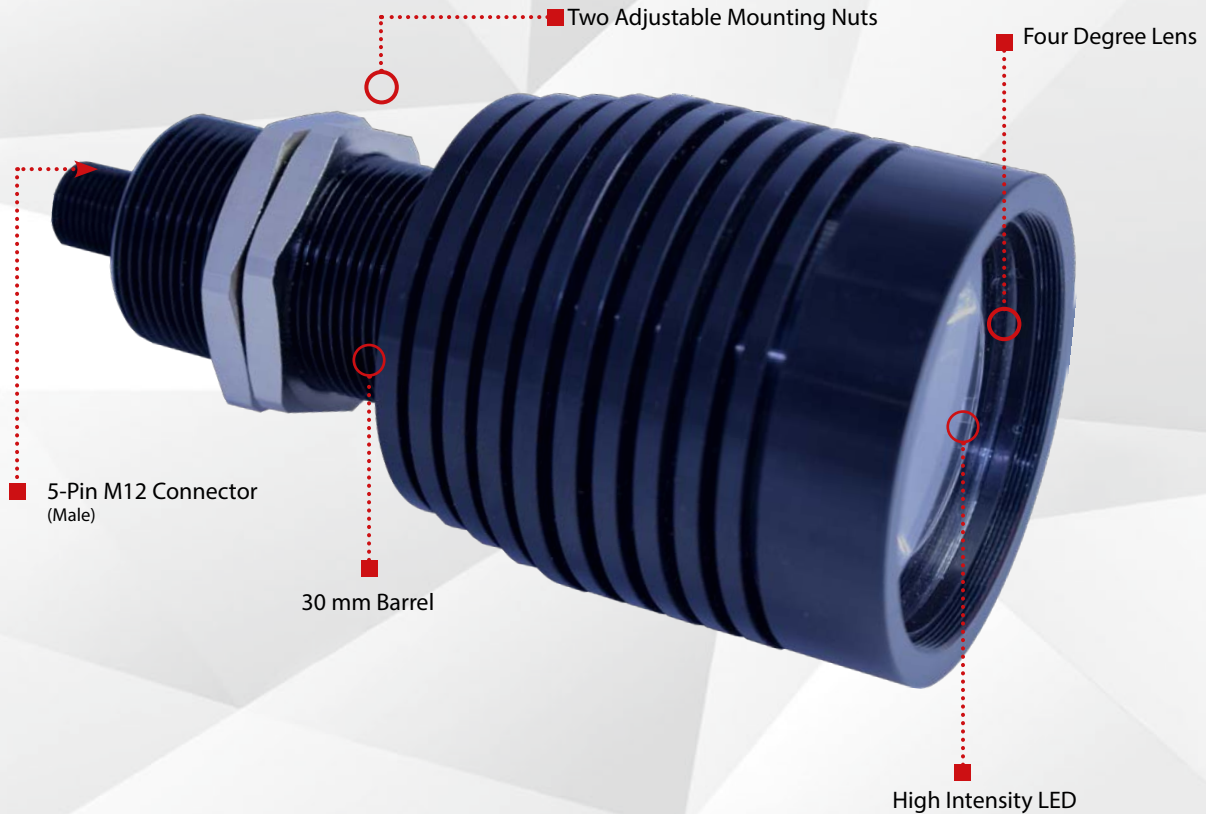

Warranty
10
YEAR

Compliant
IEC
62471

Compliant
CE
RoHS

Rated
IP
50

Connector
5 PIN
M12

PRODUCT HIGHLIGHTS

- ✓ Narrow, 4 degree lens allows for a long, tightly focused beam of light
- ✓ Built-in driver, no external wiring needed
- ✓ PNP and NPN strobe input
- ✓ 5-pin M12 quick connect
- ✓ Multiple mounting options



PRODUCT DESCRIPTION

The SX30 Series of Prox Lights feature a single high current LED enclosed in a 30mm Barrel Style Housing. The SX30 Series feature an NPN and PNP strobe signal with a 1–10 V DC analog intensity control signal for added versatility. The SX30 Series has multiple mounting options allowing for ease of install and comes with two mounting nuts.

PRODUCT SPECIFICATIONS

Electrical Input	24 V DC +/- 5%
Input Current	Max. 175 mA
Wattage	Max. 6 W
Strobe Input	PNP > +4 V DC or greater to activate NPN > GND (<1 V DC) to activate
PNP Line	4 mA @ 4 V DC 10 mA @ 12 V DC 20 mA @ 24 V DC
NPN Line	15 mA @ Ground (0VDC)
Continuous Mode	NPN can be tied to ground OR PNP can be tied to 24 V DC (not both)
Red Indicator LED	LED Strobe Indicator ON = Light Active
Green Indicator LED	ON = Power
Analog Intensity	The output is adjustable from 10–100% of brightness by a 1–10 V DC signal. (Jumpering pin 5 to pin 1 will provide maximum intensity)
Connection	5-pin M12 connector
Ambient Temperature	-18°–40° C (0°–104° F)
IP Rating	IP50
Weight	~320g
Compliances	CE, RoHS, IEC 62471

WIRING CONFIGURATION

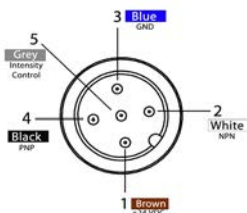

Pins	Function	Signal	Wire Color
1	Power In	+24 V DC	BROWN
2	NPN	Sinking Signal	WHITE
3	GND	Ground	BLUE
4	PNP	Sourcing Signal	BLACK
5	Intensity Control	1 - 10 V DC	GREY*

* Some cables use green/yellow for pin 5

OPTIONAL
For maximum intensity, analog intensity may be connected to +V DC (24 V DC) - Jumper pin 5 to pin 1

PRODUCT DRAWING

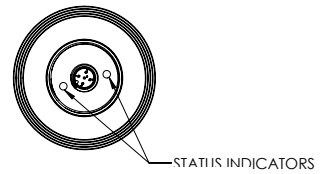
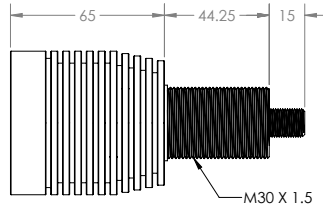
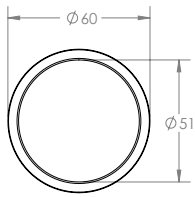

CAD files available on our website.
Dimensions are in mm.

ILLUMINATION

SX30 (N4) series of Linear Lights works best for:

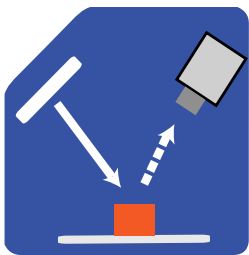

Bright Field

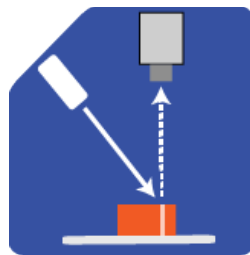

Projector

LIGHT PATTERNS

Smart Vision Lights recommends the SX30 (N4) be used at a working distance between 500 mm to 4000 mm.

Illumination measurement taken on White Light – 6500 K

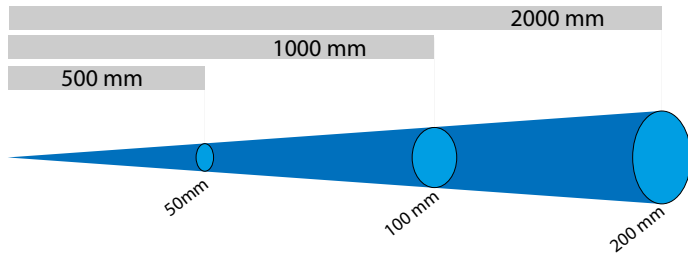

LIGHTING PATTERN FOR THE SX30 (N4) with 4° (narrow) Lenses

Working Distance mm (inches)	Pattern (80% - 100% measured intensity) mm (inches)
500 mm (19.7")	50 mm (~2")
1000 mm (39.4")	100 mm (~3.9")
2000 mm (78.8")	200 mm (~7.8")

Typical Output Performance	Illumination (Lux)
Distance = 500 mm	50,000

Illumination measurement taken on White Lights – 6500K

The SX30 (N4) produces a uniform light pattern.

(Grid set to 25 mm x 25 mm)

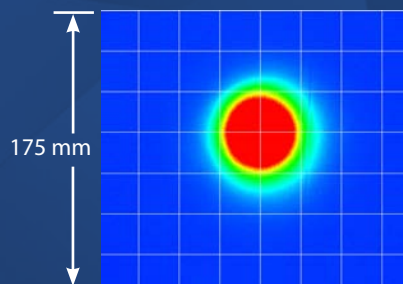

Working Distance: 500 mm

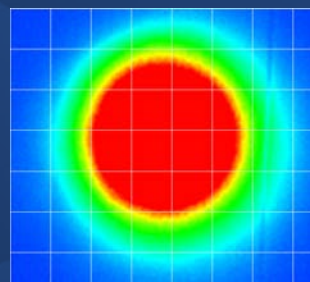

Working Distance: 1000 mm

PART NUMBER

SX30 – – N4

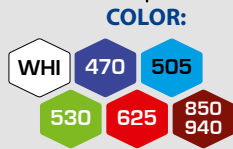

Part Number Examples:
SX30-625-N4 SX30, 625 Red Wavelength,
 Narrow 4 Degree Lens



This light is available in our SWIR LEDs
 (1050 nm, 1200 nm, 1300 nm, 1450 nm, 1550 nm)

*Additional wavelengths options available upon request.
 UV wavelengths not available.*

MOUNTING

Two M30 nuts for mounting are included with the light.

Example of the SX30 (N4) shown using the Slotted Right Angle mount (**Part Number: PB30-M3**).

See accessories for additional mounting options.

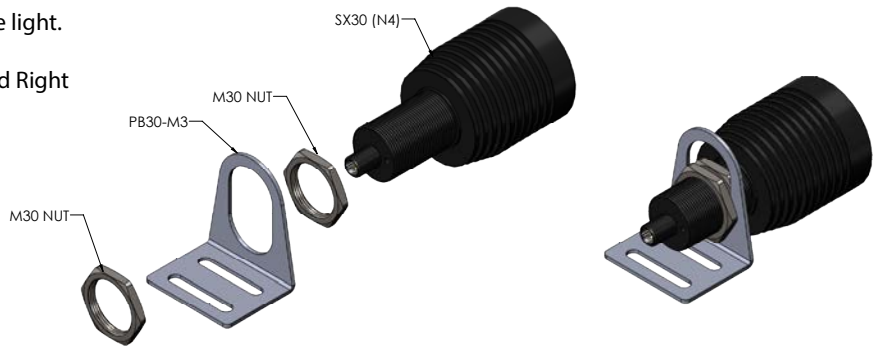

EYE SAFETY



According to IEC 62471:2006. Full documentation upon request.

Notice

Exempt Group: No photobiological hazard to eyes or skin even for continuous, unrestricted use. Applicable for wavelengths: 625, 850, and 940.

Caution

Risk Group 1: Possibly hazardous optical radiation emitted from this product. Do not stare at operating lamp. May be harmful to eye. Safe for most applications except prolonged exposures. Applicable for wavelengths: 470, 505, 530, and WHI.

ACCESSORIES

Power Cables	
	
Lengths	Part Number
5 m	5PM12-5
10 m	5PM12-10
15 m	5PM12-15

Mount	
	
Description	Part Number
Swivel Mount	PB30-M1

Mount	
	
Description	Part Number
Slotted Block Mount	PB30-M2

Power Adapters *	
	
Description	Part Number
AC, 24 Volt, 1.7 Amp	T1 Power Supply

* European Versions Available (Add -EURO to end of T1 or T2. Example T1-EURO Power Supply)

Mount	
	
Description	Part Number
Slotted Right Angle	PB30-M3

Mount	
	
Description	Part Number
Blot-on Block Mount	PB30-M6

GLOSSARY

This glossary covers all Smart Vision Lights product families; some content in this section may not apply to this specific light.

TERMINOLOGY

OverDrive™ Lights include an integrated high-pulse driver for complete LED light control. OverDrive™ light part numbers start with OD.

Continuous Operation Lights stays on continuously.

Multi-Drive™ Combines continuous operation and OverDrive™ strobe (high-pulse operation) mode into one easy-to-use light.

Built-in Driver The built-in driver allows full function without the need of an external controller.

Camera to Light Connecting the light directly to the camera, without the need for additional controllers or equipment.

Polarizers Filters that reduce reflections on specular surfaces.

Diffusers Used to widen the angle of light emission, reduce reflections and increase uniformity.

TYPES OF ILLUMINATION

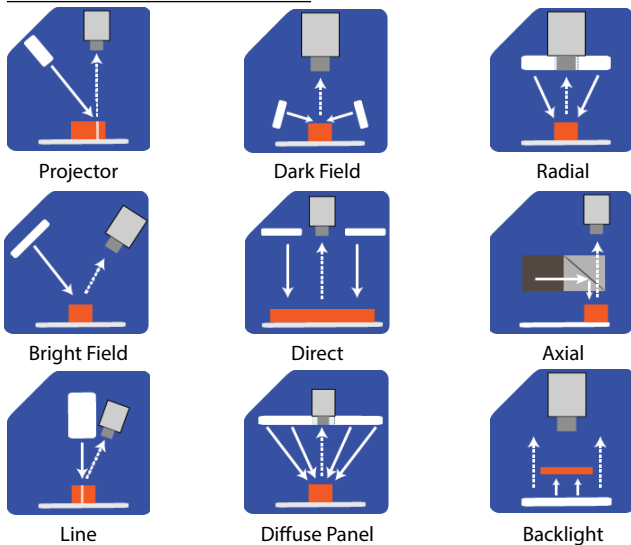

COLOR/WAVELENGTHS LEGEND

Wavelengths options range from 365 nm to 1550 nm. * Additional wavelengths available for many light families.

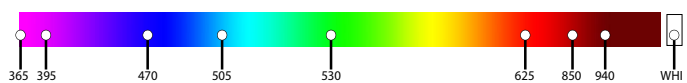

*See Part Number section for **this light's** available standard wavelengths.



Shortwave Infrared LEDs are available in 1050 nm, 1200 nm, 1300 nm, 1450 nm, and 1550 nm.