

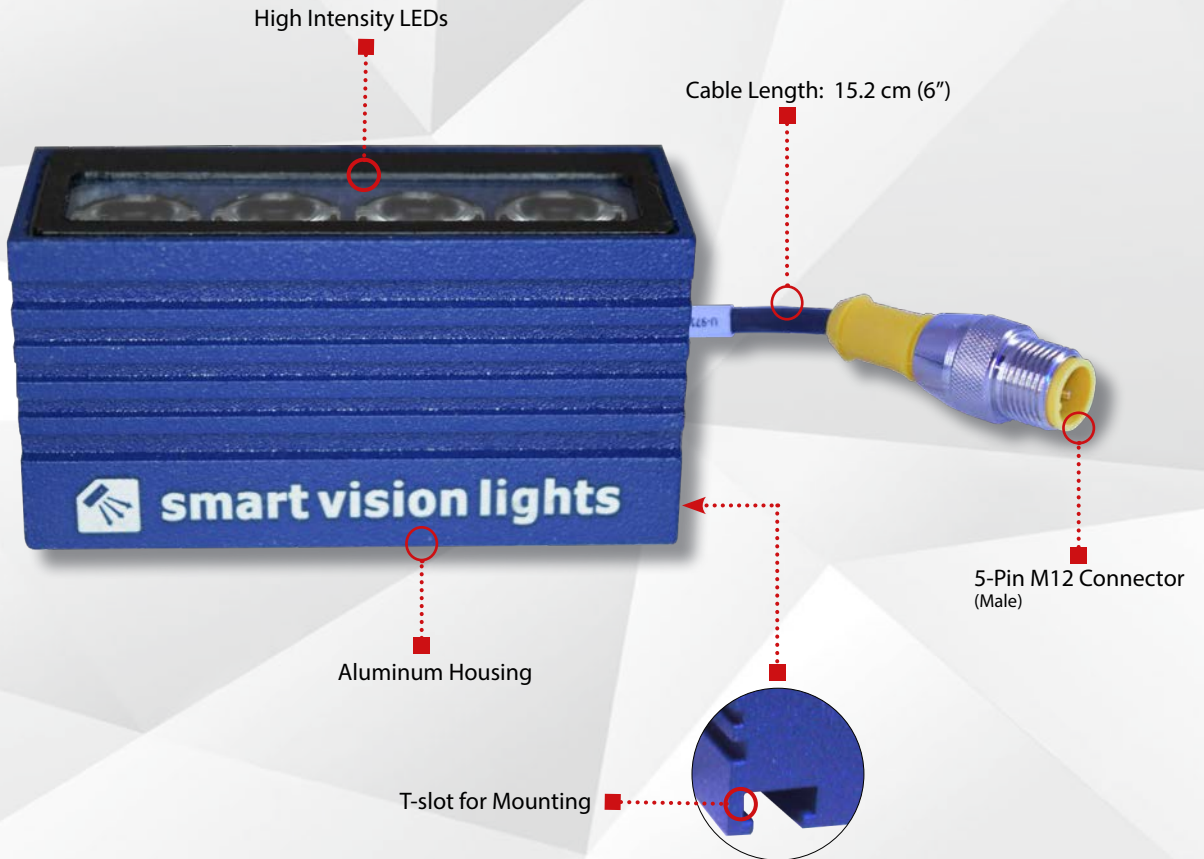

smart vision lights

LM45 Miniature "Mini" LINEAR LIGHT MULTI-DRIVE™

P R O D U C T D A T A S H E E T



Warranty 10 YEAR	Compliant IEC 62471	Compliant CE RoHS	Rated IP 65	Connector 5-PIN M12
-------------------------------	----------------------------------	--------------------------------	---------------------------------	---

PRODUCT HIGHLIGHTS

- ✓ Delivering up to 42,000 LUX in OverDrive™ mode with standard lenses
- ✓ Built-in Multi-Drive™ allows the light to work in continuous operation or OverDrive™ mode
- ✓ PNP and NPN strobe input
- ✓ Over-current protection
- ✓ 5-pin M12 quick connect



PRODUCT DESCRIPTION

The LM45 compact linear light features an integrated Multi-Drive™ constant current driver that operates continuously or in OverDrive™ strobe mode depending on wiring method. The light can be mounted via a rear T-slot channel, also offers overcurrent protection and PNP and NPN strobe input.

PRODUCT SPECIFICATION

	CONTINUOUS OPERATION	OVERDRIVE™ OPERATION
Electrical Input	24 V DC +/- 5%	
Input Current	Max. 140 mA	Max. 1.26 A
Wattage	Max. 2.88 W	Max. 31.6 W
PNP Line	4 mA @ 4 V DC 10 mA @ 12 V DC 20 mA @ 24 V DC	
NPN Line	15 mA @ Common (0 V DC)	
OverDrive™ Mode	Not applicable	Connect pin 5 to GND (see Wiring Configuration for more information)
Strobe Duration	Not applicable	Min. 10 μ s Max. 50 ms
Duty Cycle	Not applicable	Max. 10%
Strobe Input	Not applicable	PNP > +4 V DC or greater to activate NPN > GND (<1 V DC) to activate
Continuous Operation Mode	NPN can be tied to ground OR PNP can be tied to 24VDC (not both)	Not applicable
On/Off Input	PNP > +4 V DC or greater to activate NPN > GND (<1 V DC) to activate	Not applicable
Connection	5-pin M12 connector	
Ambient Temperature	-18°-40° C (0°-104° F)	
IP Rating	IP65	
Weight	54g	
Compliances	CE, RoHS, IEC-62471	

PRODUCT DRAWING

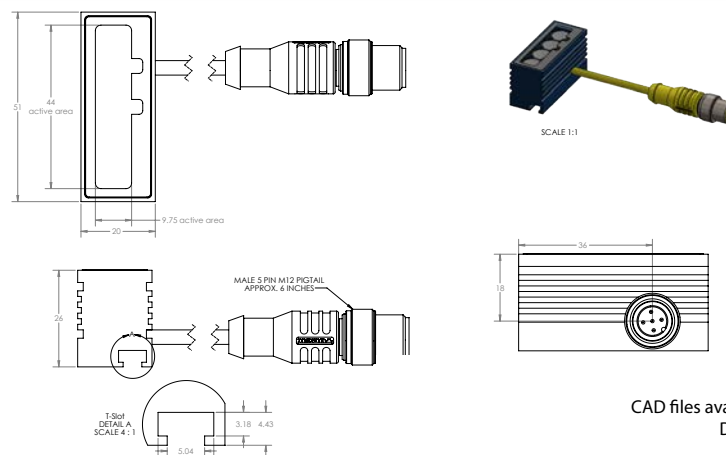

CAD files available on our website.
Dimensions are in mm.

WIRING CONFIGURATION

CONTINUOUS OPERATION MODE

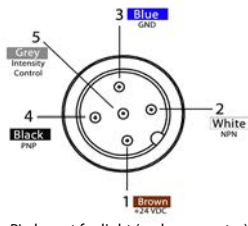

Pins	Function	Signal	Wire Color
1	Power In	+24VDC	BROWN
2	NPN	Sinking Signal	WHITE
3	GND	Ground	BLUE
4	PNP	Sourcing Signal	BLACK
5	Intensity Control	1-10 V DC	GREY*

For the light to function properly, apply either a PNP or NPN signal, not both.
 Failure to supply light with correct input current will result in non-repeatable lighting (see Product Specifications for requirements)

* Some cables use green/yellow for pin 5
 For maximum intensity, it is possible to tie pin 5 to pin 1 at +24 VDC.
 For continuous mode: PNP (pin 4) can be tied to +24 V DC (pin 1) or NPN (pin 2) can be tied to Ground (pin 3).

OVERDRIVE™ OPERATION MODE

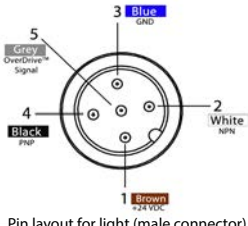

Pins	Function	Signal	Wire Color
1	Power In	+24VDC	BROWN
2	NPN	Sinking Signal	WHITE
3	GND	Ground	BLUE
4	PNP	Sourcing Signal	BLACK
5	OverDrive™ Signal	Ground	GREY*

Failure to supply light with correct input current will result in non-repeatable lighting (see Product Specifications for requirements)

* Some cables use green/yellow for pin 5

LENSES

STANDARD

Standard lenses project a narrower beam of illumination. They can be used when long working distances are needed. Standard are 40° angle lenses. Best used for working distance between 200 mm and 1000 mm.

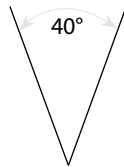

WIDE (w)

Wide lenses project a large area of illumination. Wide lenses can be used when short working distances are needed. Wide are 80° angle lenses. Best used for working distance between 50 mm and 1000 mm.

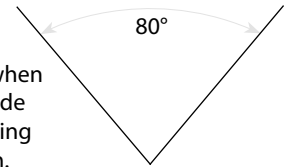

NARROW 16° (N16)

Narrow, 16° angle lenses project a narrower beam of illumination. They can be used when longer distances are needed. Best used for working distance between 300 mm and 2000 mm.



NARROW 25° (N25)

Narrow, 25° angle lenses project a narrower beam of illumination. They can be used when longer distances are needed. Best used for working distance between 300 mm and 2000 mm.

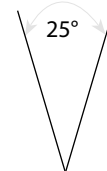

LINE (L)

Line, 10° and 50° angle cone lenses create a thin narrow beam of illumination.

Additional lens options available upon request.

The LM45 Mini Linear Light produces a uniform light pattern.

Working Distance = 500 mm

(Grid set to 65 mm x 65 mm)

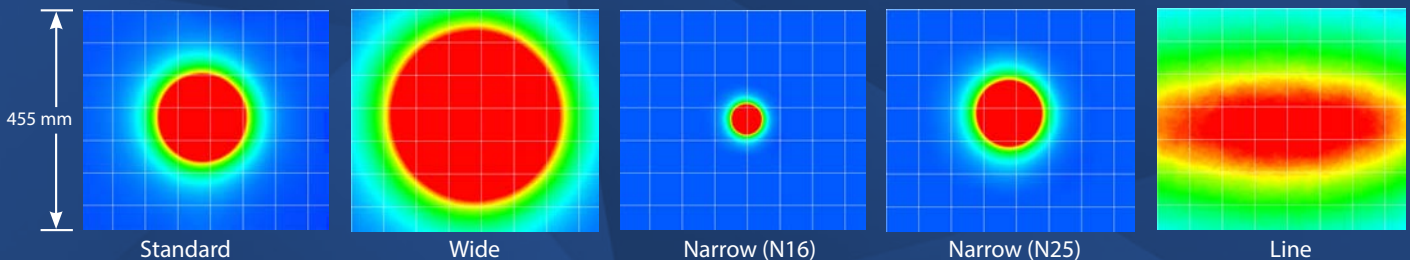



LIGHT PATTERNS

Smart Vision Lights recommends the LM45 be used at a working distance between 50 mm to 1000 mm.

LIGHTING PATTERN FOR THE LM45 with Standard 40° Lenses

Working Distance mm (inches)	Pattern (80% – 100% measured intensity) mm (inches)
250 mm (9.84")	110 mm (~4.3") H x 110 mm (~4.3") V
500 mm (19.7")	220 mm (~8.7") H x 220 mm (~8.7") V

Continuous Operation Mode

Typical Output Performance	Illumination (Lux)
Distance = 250 mm	4200
<i>Illumination measurement taken on White Light – 6500K</i>	

OverDrive™ Mode

Typical Output Performance	Illumination (Lux)
Distance = 250 mm	42,000
<i>Illumination measurement taken on White Light – 6500K</i>	

LIGHTING PATTERN FOR THE LM45 with Wide 80° Lenses (W)

Working Distance mm (inches)	Pattern (80% – 100% measured intensity) mm (inches)
250 mm (9.84")	220 mm (~8.7") H x 220 mm (~8.7") V
500 mm (19.7")	440 mm (~17.3") H x 440 mm (~17.3") V

Continuous Operation Mode

Typical Output Performance	Illumination (Lux)
Distance = 250 mm	1500
<i>Illumination measurement taken on White Light – 6500K</i>	

OverDrive™ Mode

Typical Output Performance	Illumination (Lux)
Distance = 250 mm	15,000
<i>Illumination measurement taken on White Light – 6500K</i>	

LIGHTING PATTERN FOR THE LM45 with Narrow 16° Lenses (N16)

Working Distance mm (inches)	Pattern (80% – 100% measured intensity) mm (inches)
500 mm (19.7")	75 mm (~3.0") H x 75 mm (~3.0") V
1000 mm (39.4")	150 mm (~6.0") H x 150 mm (~6.0") V

Continuous Operation Mode

Typical Output Performance	Illumination (Lux)
Distance = 500 mm	4500
<i>Illumination measurement taken on White Light – 6500K</i>	

OverDrive™ Mode

Typical Output Performance	Illumination (Lux)
Distance = 500 mm	45,000
<i>Illumination measurement taken on White Light – 6500K</i>	

LIGHTING PATTERN FOR THE LM45 with 25° Narrow Lenses (N25)

Working Distance mm (inches)	Pattern (80% – 100% measured intensity) mm (inches)
500 mm (19.7")	170 mm (~6.7") H x 170 mm (~6.7") V
1000 mm (39.4")	340 mm (~13.4") H x 340 mm (~13.4") V

Continuous Operation Mode

Typical Output Performance	Illumination (Lux)
Distance = 500 mm	2700
<i>Illumination measurement taken on White Light – 6500K</i>	

OverDrive™ Mode

Typical Output Performance	Illumination (Lux)
Distance = 500 mm	27,000
<i>Illumination measurement taken on White Light – 6500K</i>	

LIGHTING PATTERN FOR THE LM45 with Line Lenses

Working Distance mm (inches)	Pattern (80% – 100% measured intensity) mm (inches)
500 mm (19.7")	230 mm (~9") H x 60 mm (~2.4") V
1000 mm (39.4")	460 mm (~18") H x 120 mm (~4.8") V

Continuous Operation Mode

Typical Output Performance	Illumination (Lux)
Distance = 500 mm	1750
<i>Illumination measurement taken on White Light – 6500K</i>	

OverDrive™ Mode

Typical Output Performance	Illumination (Lux)
Distance = 500 mm	17,500
<i>Illumination measurement taken on White Light – 6500K</i>	

MULTI-DRIVE™

Multi-Drive™ allowing users to operate the light in continuous operation or OverDrive™ strobe (high-pulse operation) mode. An advantage of Multi-Drive™ is faster imaging. It also enhances capture/freeze motion imaging on high-speed lines.



The Multi-Drive™ feature allows the user to run the light in continuous operation or OverDrive™ strobe mode at maximum intensity. OverDrive™ strobe mode is **up to ten times** the power of continuous operation.

DUTY CYCLE (OVERDRIVE™ MODE ONLY)

This section applies only if light is in OverDrive™ Mode.

The Duty Cycle (D) is related to the Strobe Time (ST) and Rest Time (RT).

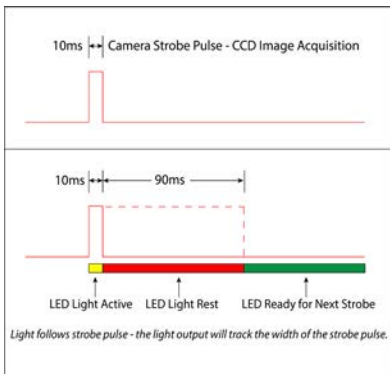

Calculating Rest Time

$$RT = \frac{ST}{D} - ST$$

RT = Rest Time
ST = Strobe Time
D = Duty Cycle

Example

$$RT = \frac{10 \text{ ms}}{.1} - 10 \text{ ms} = 90 \text{ ms}$$

Rest Time is 90 ms for 10 ms Strobe Time

Maximum Duty Cycle for OverDrive™ light is 10% (0.1)

ILLUMINATION

LM45 Series of Miniature "Mini" Linear Lights works best for:

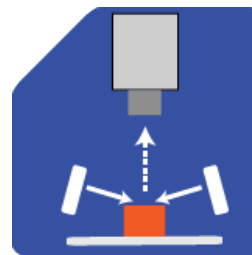

Dark Field

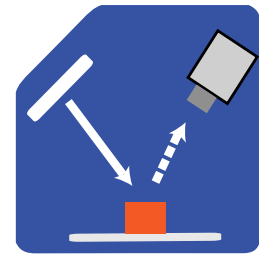

Bright Field

EYE SAFETY

According to IEC 62471: 2006. Full documentation available upon request.



Notice

Exempt Group: No photobiological hazard to eyes or skin even for continuous, unrestricted use. Applicable for wavelengths: 625, and 850.

Caution

Risk Group 1: Possibly hazardous optical radiation emitted from this product. Do not stare at operating lamp. May be harmful to eyes. Safe for most applications except prolonged exposure. Applicable for wavelengths: 470, 530, and WHI.

PART NUMBER

LM45



COLOR:



LENS:

Leave blank for Standard (40°)

W = Wide (80°)

N16 = 16° lens

N25 = 25° lens

L = Line lens

Part Number Examples:

- LM45-625 (LM45, 625 Red Wavelength)
- LM45-WHI-W (LM45, White Wavelength, Wide Lenses)
- LM45-470-N16 (LM45, 470 Blue Wavelength, Narrow 16° Lenses)

MOUNTING

Mounting options include T-slot on bottom of light.

Hardware includes:

- (2) M4 x 16 screws
- (2) M4 nylon nuts



Optional Mounting Bracket



The **optional BKT0025** can be used to mount the LM45.

Easily connect together multiple LM45 using the BKT0025 bracket. The unique design of the BKT0025 bracket allows for any combination of lights to be easily connected together.

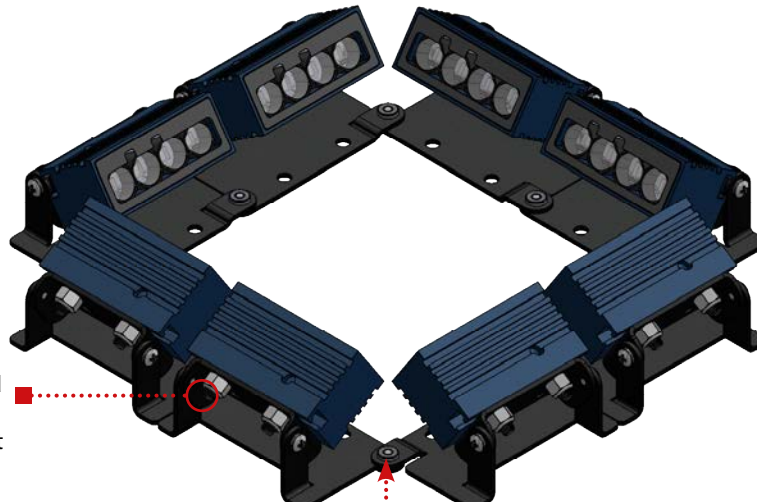

Use screws and nuts to attach LM45 to mount

One M3 x 5 mm screw connects the mounts



ACCESSORIES

Power Cables		Splitter		Jumper Cables (Used with Splitter)		Power Adapters *	
Lengths	Part Number	Description	Part Number	Lengths	Part Number	Description	Part Number
5 m	5PM12-5	5-pin 2 way splitter	5PM12-2SW	300 mm	5PM12-J300	AC, 24 Volt, 1.7 Amp	T1 Power Supply
10 m	5PM12-10			1000 mm	5PM12-J1000		
15 m	5PM12-15			2000 mm	5PM12-J2000		
10 m	HF5PM12-10 (High Flex)						
		Mounting Bracket					
		Description	Part Number				
		LM45 Mount	BKT0025				

* European Versions Available (Add -EURO to end of T1 or T2. Example T1-EURO Power Supply)



GLOSSARY

This glossary covers all Smart Vision Lights product families; some content in this section may not apply to this specific light.

TERMINOLOGY

OverDrive™ Lights include an integrated high-pulse driver for complete LED light control. OverDrive™ light part numbers start with OD.

Continuous Operation Lights stays on continuously.

Multi-Drive™ Combines continuous operation and OverDrive™ strobe (high-pulse operation) mode into one easy-to-use light.

Built-in Driver The built-in driver allows full function without the need of an external controller.

Camera to Light Connecting the light directly to the camera, without the need for additional controllers or equipment.

Polarizers Filters that reduce reflections on specular surfaces.

Diffusers Used to widen the angle of light emission, reduce reflections and increase uniformity.

TYPES OF ILLUMINATIONS

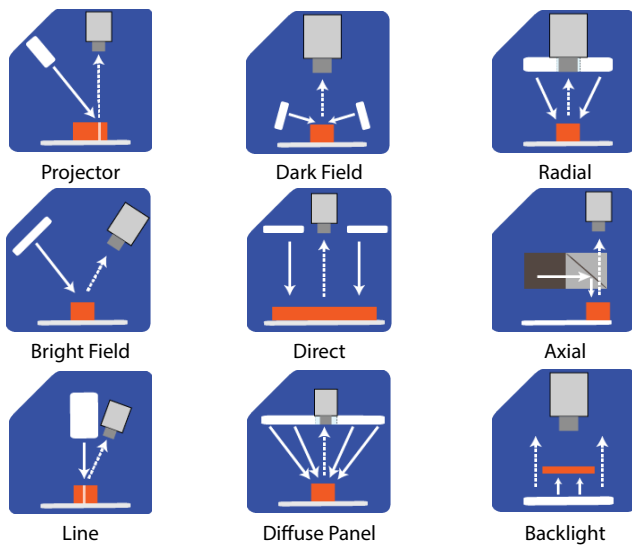

COLOR/WAVELENGTHS LEGEND

Wavelengths options range from 365 nm to 1550 nm. *
Additional wavelengths available for many light families.

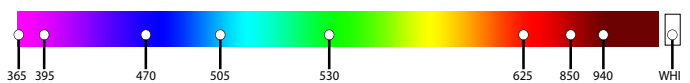

*See Part Number section for **this light's** available standard wavelengths.



Short Wave Infrared LEDs are available in 1050 nm, 1200 nm, 1300 nm, 1450 nm, and 1550 nm.